

Scotsman[®]

Commercial Product Guide

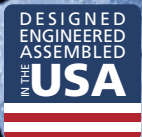

Scan to learn more

Table of Contents

Introduction	3-7
Why Scotsman?	3
Recognition/Certification	3
Sales & Marketing Tools	4
Model Identification	5
Ice Forms	6
Machine Sizing Guidelines	7
Modular Cube Ice Machines	8-13
Modular Cube Features & Benefits	8
Modular Cube Units	9-10
Modular Cube Kits & Accessories	11
Modular Cube / Remote Condenser Packages	12-13
Undercounter Gourmet Cube Units	13
Undercounter Cube Ice Machines	14-15
Undercounter Cube Features & Benefits	14
Undercounter Cube Units & Accessories	15
Modular Flake Ice Machines	16-17
Modular Flake Features & Benefits	16
Modular Flake Units	17
Modular Nugget Ice Machines	18-21
Modular Nugget Features & Benefits	18
Modular Nugget Units	19
Remote Low Side Nugget / Flake Units	20
Nugget / Flake Kits & Accessories	21
Undercounter Nugget & Flake Ice Machines	22-23
Undercounter Nugget / Flake Features & Benefits	22
Undercounter Nugget / Flake Units & Accessories	23
Ice & Water Dispensers	24-27
Ice & Water Dispenser Features & Benefits	24
Ice & Water Dispensers	25
Dispenser Stands	25
Hotel / Motel Dispensers & Accessories	26
Ice Only Countertop Dispensers	26
Ice Only Dispenser Kits & Accessories	27
Bins & Sanitation	27-35
Storage Bins	27
Ice Express System & Bin Accessories	28
Bin Top Kits / Accessory Kits	29
Sanitation & Water Filtration	30-31
Ice Machine to Dispenser Kit Chart	33
Machine / Bin Sizing Chart	34-35
Index	36-38
Warranty & Definitions	39

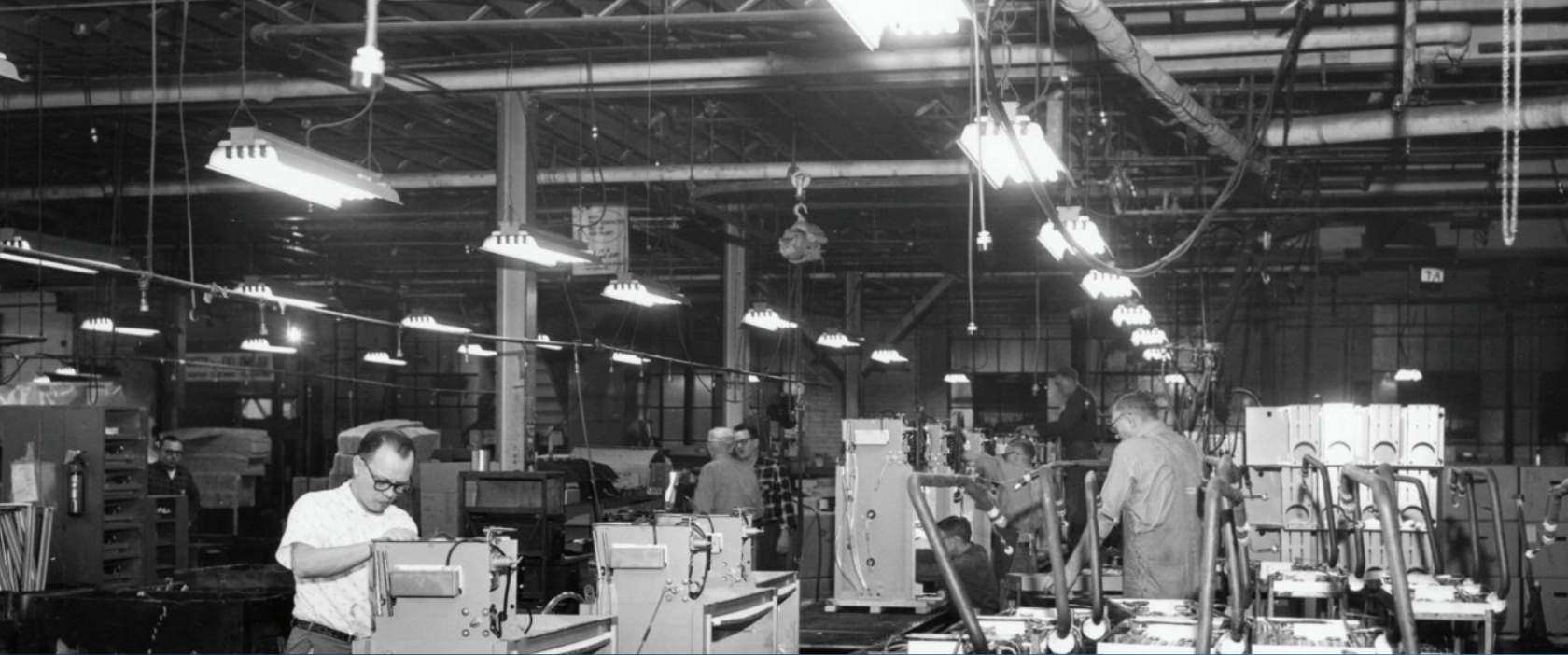

Why Scotsman®?

Inside Scotsman's Factory in Albert Lea, Minnesota, workers assemble Model SC500 cubers on the production line, early 1960s.



Award Winning Manufacturing & Products

Smooth-running equipment means operators can stay focused on what matters most: their customers. That's why Scotsman provides smart technology that alerts operators early, well before issues arise.



24/7 Technical Support

Our Technical Service team offers a 24-hour emergency line, so a Scotsman representative is always available when you need support. You'll also find a dedicated section on our website with detailed technical resources.



Focus on Energy & Savings

Scotsman offers a range of ENERGY STAR® certified models, each designed to reduce energy and water consumption. Our efficient designs help protect the environment while supporting your bottom line. Look for the ★ symbol throughout the price book to identify qualified products.

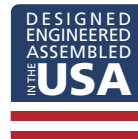

Designed, Engineered, & Assembled in the USA

At Scotsman, our commitment to quality starts at our award-winning production facility in South Carolina. With 99% of our equipment built in the U.S., we take pride in keeping production close to home.



Certified Product Performance

Scotsman ice machines and bins are certified by AHRI, ensuring verified performance and reliability. We're also ISO 9001:2015 certified, with every unit undergoing a 100% quality check before leaving our facility.



Innovative Sales Tools & Training

Scotsman provides powerful tools to help customers and partners better understand our products like the Resource Center, Sales App, Sizing and Selector Tool, Comparison Tool, and more.

Sales & Marketing Tools

The **Scotsman Resource Center** is our centralized home for downloadable specs, marketing collateral, sales tools, and technical support materials. Designed for distributors and service partners, it's built to provide everything you need to promote and understand Scotsman products.

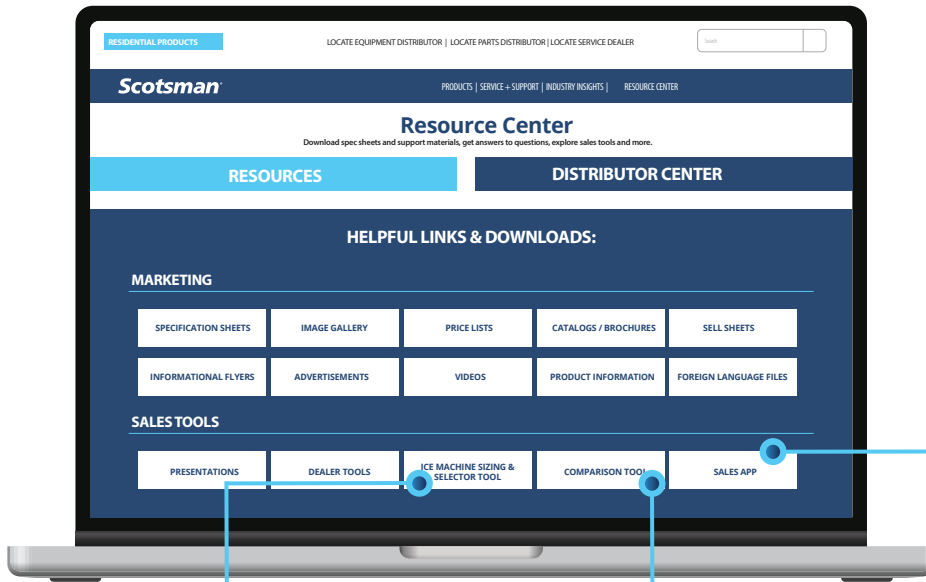

Sales App

A web-based microsite with access to presentations, images and videos, marketing literature and interactive tools.



Comparison Tool

This tool can be used to find the closest machine for a complete comparison of specifications and operating costs.



Ice Machine Sizing & Selector Tool

This tool can be used to find the right machine for your operation by estimating ice usage and sorting models by application, form, width, and placement.



Price List Tool

This tool organizes the most current Scotsman pricing into a searchable, interactive table. Start typing a part number and the filtering will activate.

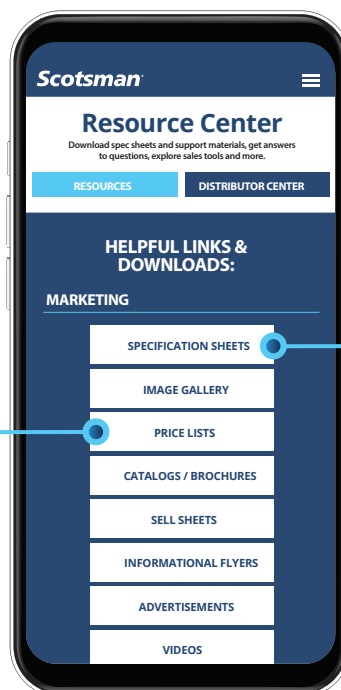

Specification Sheets

Access specification sheets for every Scotsman ice machine model, featuring detailed technical data on production capacities, dimensions, electrical requirements, and more.

Model Identification

Your Guide to Model Numbers

Easily read any **Scotsman model code** - see how each digit and letter translates into key specs like size, cube type, and condenser style.

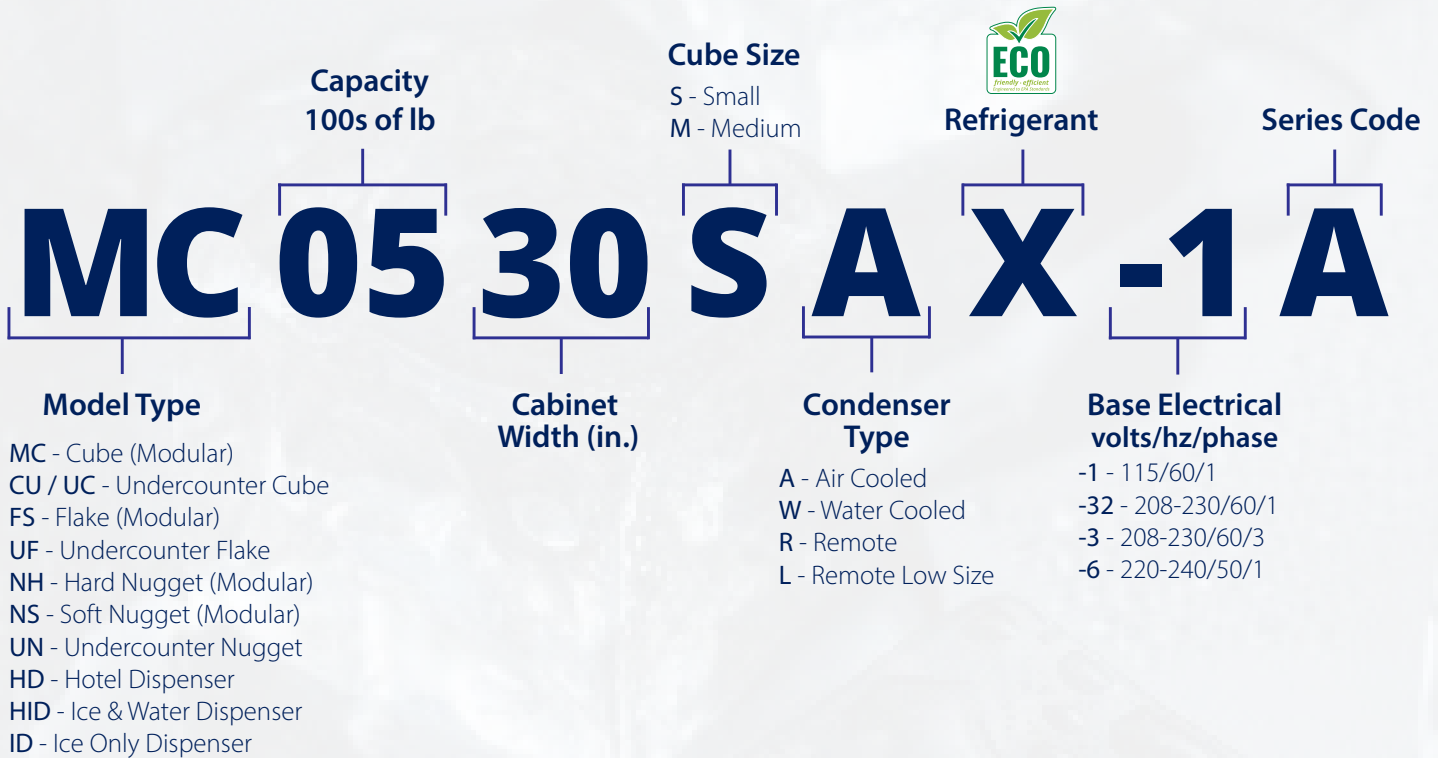

Production Date Code Guide

Scotsman serial numbers include a built-in date code. The 2-digit year is followed by the 2-digit month, allowing technicians to quickly confirm when the unit was manufactured before proceeding with service or warranty checks.



2306 = Manufactured June, 2023

An Ice Form to Meet Every Need



ORIGINAL CHEWABLE NUGGET ICE

The smallest, softest and most chewable, our proprietary nugget ice is The Original Chewable Ice - a customer favorite for decades.

APPLICATIONS:

Carbonated Beverages
Food Displays
Therapeutic Applications

SIZE:

7/16" x 5/16" x 3/8"



H² NUGGET ICE

Slightly harder, slower melting, nugget ice form that combines more reliable dispensing with the chewable ice that customers love.

APPLICATIONS:

Carbonated Beverages
Food Displays
Improved Ice Dispensing
Therapeutic Applications

SIZE:

3/4" x 5/16" x 3/8"



SMALL & MEDIUM CUBE ICE

Our familiar crystal-clear diced ice cube form, available in both small and medium sizes to fit your needs.

APPLICATIONS:

Mixed Drinks
Carbonated Beverages
Ice Dispensing
Banquet Services

SIZE:

Small: 7/8" x 7/8" x 3/8"
Medium: 7/8" x 7/8" x 7/8"



FLAKE ICE

These small pieces of ice combine fast cooling power with very low production costs.

APPLICATIONS:

Blended Cocktails
Salad Bars
Meat & Seafood Displays

SIZE:

Compressed Flake Ice



GOURMET ICE

The perfect unique shape for upscale bars and restaurants.

APPLICATIONS:

Bar Use
Waitress Stations
Office Suites
Break Rooms

SIZE:

7/16" x 5/16" x 3/8"

Equipment Sizing Guidelines

Every operation has unique needs, so equipment sizing should be tailored to the situation.

New locations: Use the guidelines below as a starting point. Consider adding 10–20% extra capacity to allow for growth or for unusual applications, such as icing down drink barrels or bagging ice for resale.

Replacement units: Confirm whether the current machine meets the operator's needs. If not, add the amount of ice being purchased to the unit's production capacity to determine the necessary size of the replacement unit.

Food Service

Restaurants: 1.7 lb (0.8 kg) per customer
or 5.0 lb (2.3 kg) per seat

Cocktail Lounge: 3 lb (1.4 kg) per customer

Salad Bar: Add 35 lb (15.9 kg) per cubic foot of display. Multiply by 2 or 3 depending on estimated refills required

Fast Food: 0.9 lb (0.4 kg) per customer or
7.4 lb per seat
2 oz per 8-10 oz drink
4 oz per 12-16 oz drink

Convenience Stores/Customer Self-Service

4 oz per 12 oz drink
7 oz per 20 oz drink
10 oz per 32 oz drink
Cold plate-add 50% more

Healthcare:

8 lb (3.6 kg) per patient bed
Use 3 lb (1.4 kg) per employee

Lodging:

3 lb (1.4 kg) per guest room.
Plan on substantially more if guests are allowed to fill ice chests.

NOTE: The charts above outlines the approximate required ice amount per day, depending on application usage.



R290 Refrigerant LOOK FOR THE X!

Our new refrigerant models include an "X" identifier before the hyphen in the model number.

- ✓ **Ultra-Low Environmental Impact:** With a Global Warming Potential (GWP) of just ~3, compared to much higher values for traditional HFC refrigerants, R290 is one of the most environmentally friendly options available.
- ✓ **Enhanced Energy Efficiency:** R290 is known for its energy efficiency, allowing ice machines to operate more effectively while reducing operating costs.
- ✓ **Regulation Ready:** Aligned with evolving industry standards and regulatory requirements.

R290 is an A3 (flammable) refrigerant. Use only in approved equipment and follow all manufacturer instructions, codes, and qualified service requirements.

Scotsman®

MODULAR UNITS

PRODIGY® ELITE



Integrated ICELINQ® Mobile App

Offers real-time diagnostics, full control over settings, and step-by-step guided cleaning.



Upgraded Sensors

Improved ice thickness and water sensor design for easier cleaning and increased durability.



AutoAlert™ Panel

Features enhanced external indicator lights, including bin-full alerts and seamless Bluetooth® pairing with the ICELINQ® app.



MC0330 on B530S



Watersense Adaptive Purge

Optimizes water consumption keeping the machine cleaner and operating more efficiently.



Preservation Mode

Optimizes uptime and alerts users to potential issues.



Small & Medium Cube

Clear, hard ice cubes ideal for restaurants, bars, and beverage service.

Small Cube: 7/8" x 7/8" x 3/8"
Medium Cube: 7/8" x 7/8" x 7/8"



A SIMPLIFIED, INTUITIVE EXPERIENCE.

ICELINQ® mobile app simplifies your experience and provides intuitive operation, cleaning, and maintenance for maximum uptime.



Machine Dashboard

Intuitive display provides instant awareness of machine status and required maintenance.



Guided Cleaning

An interactive, step-by-step guide for a more efficient and thorough cleaning.



Effortless Adjustments

Simple, intuitive controls make the machine easy to use and operate.

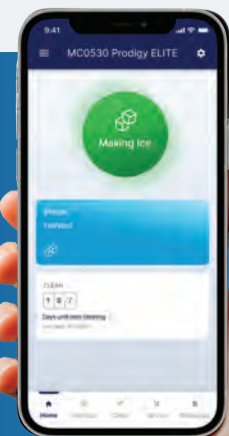

Prodigy ELITE® Modular Cube Utilizing AquaArmor™ with AgION®

*Refer to page 27 & 29 for required bins & bin top kits



22" W x 24" D x 23" H
55.9 x 61 x 58.4 cm



22" W x 24" D x 29" H
55.9 x 61 x 73.7 cm



30" W x 24" D x 23" H
76.2 x 61 x 58.4 cm



30" W x 24" D x 23" H
76.2 x 61 x 58.4 cm

Cube Size	Model Number	Condenser Type	24-Hr Ice Production		Shipping Weight lb/kg	Volts/Hz/Phase	
			70°F/21°C 50°F/10°C lb/kg	Air Water 90°F/32°C 70°F/21°C lb/kg		115/60/1 -1	208-230/60/1 -32

MC0322

Med.	MC0322MAX	Air	362/165	248/113	155/70	★	●
	MC0322MWX	Water	366/116	255/116	155/70	●	●
Sm.	MC0322SAX	Air	362/165	248/113	155/70	★	●
	MC0322SWX	Water	366/116	255/116	155/70	●	●

MC0522

Med.	MC0522MAX	Air	464/211	342/155	160/73	★	★
	MC0522MWX	Water	510/232	352/160	160/73	●	●
Sm.	MC0522SAX	Air	464/211	342/155	160/73	★	★
	MC0522SWX	Water	510/232	352/160	160/73	●	●

MC0722

Med.	MC0722MAX	Air	734/334	525/239	189/86	★	★
Sm.	MC0722SAX	Air	734/334	525/239	189/86	★	★

Cube Size	Model Number	Condenser Type	24-Hr Ice Production		Shipping Weight lb/kg	Volts/Hz/Phase	
			70°F/21°C 50°F/10°C lb/kg	Air Water 90°F/32°C 70°F/21°C lb/kg		115/60/1 -1	208-230/60/1 -32

MC0330

Med.	MC0330MAX	Air	365/166	283/129	155/70	★	●
	MC0330MWX	Water	372/169	293/133	155/70	●	●
Sm.	MC0330SAX	Air	365/166	283/129	155/70	★	●
	MC0330SWX	Water	372/169	293/133	155/70	●	●

MC0530

Med.	MC0530MAX	Air	476/216	370/168	175/80	★	●
	MC0530MR	Remote	500/227	400/181	175/80	●	●
	MC0530MWX	Water	507/230	371/168	175/80	●	●
Sm.	MC0530SAX	Air	476/216	370/168	175/80	★	●
	MC0530SR	Remote	500/227	400/181	175/80	●	●
	MC0530SWX	Water	507/230	371/168	175/80	●	●

MC0630

Med.	MC0630MAX	Air	582/265	479/218	190/86	★	★
	MC0630MR	Remote	614/279	501/228	190/86	●	●
	MC0630MWX	Water	603/274	532/242	190/86	●	●
Sm.	MC0630SAX	Air	582/265	479/218	190/86	★	★
	MC0630SR	Remote	614/279	501/228	190/86	●	●
	MC0630SWX	Water	603/274	532/242	190/86	●	●

★ = Energy Star certified.

ecoX identifies models engineered with R290 environmentally friendly refrigerant.

Combine model number and electrical indicator when ordering for exact SKU, i.e. MC0322MAX-1. See page 27 for storage bins. Please call for pricing on other international configurations.



Scan to View
Current Pricing

Prodigy ELITE® Modular Cube Utilizing AquaArmor™ with AgION®

*Refer to page 27 & 29 for required bins & bin top kits



30" W x 24" D x 29" H
76.2 x 61 x 73.7 cm

Cube Size	Model Number	Condenser Type	24-Hr Ice Production		Shipping Weight lb/kg	Volts/Hz/Phase	
			70°F/21°C 50°F/10°C lb/kg	Air Water 90°F/32°C 70°F/21°C lb/kg		208-230/60/1 -32	208-230/60/3 -3

MC0830

Med.	MC0830MAX	Air	921/419	708/322	220/100	●	
	MC0830MR	Remote	870/395	780/355	220/100	●	
	MC0830MWX	Water	907/412	784/356	220/100	●	
Sm.	MC0830SAX	Air	921/419	708/322	220/100	●	
	MC0830SR	Remote	870/395	780/355	220/100	●	
	MC0830SWX	Water	907/412	784/356	220/100	●	

MC1030

Med.	MC1030MAX	Air	1041/473	782/355	235/107	●	
	MC1030MR	Remote	996/453	869/395	235/107	●	●
	MC1030MWX	Water	983/447	855/389	235/107	●	
Sm.	MC1030SAX	Air	1041/473	782/355	235/107	●	
	MC1030SR	Remote	996/453	869/395	235/107	●	●
	MC1030SWX	Water	983/447	855/389	235/107	●	

Cube Size	Model Number	Condenser Type	24-Hr Ice Production		Shipping Weight lb/kg	Volts/Hz/Phase	
			70°F/21°C 50°F/10°C lb/kg	Air Water 90°F/32°C 70°F/21°C lb/kg		208-230/60/1 -32	208-230/60/3 -3

MC1448

Med.	MC1448MA	Air	1553/706	1188/539	345/157	●★	●★
	MC1448MR	Remote	1357/617	1154/617	345/157	●	●
	MC1448MW	Water	1444/656	1229/557	345/157	●	●
Sm.	MC1448SA	Air	1553/706	1188/539	345/157	●★	●★
	MC1448SR	Remote	1357/617	1154/617	345/157	●	●
	MC1448SW	Water	1444/656	1229/557	345/157	●	●

MC1848

Med.	MC1848MA	Air	1909/868	1426/647	345/157	●	
	MC1848MR	Remote	1828/831	1662/754	345/157	●	●
	MC1848MW	Water	1900/864	1668/757	345/157	●	
Sm.	MC1848SA	Air	1909/868	1426/647	345/157	●	
	MC1848SR	Remote	1828/831	1662/754	345/157	●	●
	MC1848SW	Water	1900/864	1668/757	345/157	●	

MC2148

Med.	MC2148MR	Remote	1965/893	1746/794	370/168	●	●
Sm.	MC2148SR	Remote	1965/893	1746/794	370/168	●	●

MC2648

Med.	MC2648MR	Remote	2630/1193	2131/967	430/195		●
	MC2648SR	Remote	2630/1193	2131/967	430/195		●



48" W x 28.5" D x 34" H
121.9 x 72.4 x 86.4 cm

Modular Cube Kits and Accessories

Model Number	Description	Unit Dimensions (W x D x H)	Shipping Weight lb/kg	Volts/Hz/Phase		
				115/60/1 -1	208-230/60/1 -32	230/50/1 -6
Remote Condensers						
ERC111	Remote condenser for MC0530xR	29.5" x 29.13" x 38.47" 74.9 x 74.0 x 97.7 cm	95/43	●		
ERC311	Remote condenser for MC0630xR, MC0830xR, MC1030xR, or MC1448xR	29.5" x 29.13" x 38.47" 74.9 x 74.0 x 97.7 cm	130/59		●	●
ERC611	Remote condenser for MC1848xR or MC2148xR (Works with 50 Hz and 60 Hz units)	29.5" x 37.8" x 38.47" 74.9 x 96.0 x 97.7 cm	140/84		●	
PRC241	Remote condenser for MC2648xR	28.5" x 39" x 34.63" 72.4 x 99.1 x 87.9 cm	135/61		●	

Model Number	Description	Shipping Weight lb/kg
Miscellaneous		
KERCF	Air filter for ERC111 or ERC311	5/2
RCKCME6GX-E	Remote condensing kit for connecting E revision Prodigy® models to non-Scotsman remote condenser coils, Quick connects not included	25/11
KTPS-SM	Tamper Proof Screw Kit (incl. Tool) to convert 22" (55.9cm), 30" (76.2 cm) or 48" (121.9 cm) cuber	5/2

Line Sets		
BRTE10	Line set, 10 ft, brazing required	7/3
BRTE25	Line set, 25 ft, brazing required	12/6
BRTE40	Line set, 40 ft, brazing required	17/8
BRTE75	Line set, 75 ft, brazing required	35/16
KTE4	Tube end kit - contains 4 quick connect fittings for any RTE Line Set	5/2
BRTEL25	Line set, 25 ft (7.6m), use with C2648 remote cooled units, brazing required	16/7
BRTEL40	Line set, 40 ft (12.2m), use with C2648 remote cooled units, brazing required	22/10
BRTEL75	Line set, 75 ft (22.9m), use with C2648 remote cooled units, brazing required	40/18
KTEL4	Tube end kit - contains 4 quick connect fittings for any RTEL Line Set	5/2

Prodigy ELITE® Modular Cube Accessories		
KPAS	Kit - Prodigy Advanced Sustainability. Includes KSBU-N and KVS	10/4
KSBU	Kit - Prodigy Smart-Board™ - Use additional operational data for fast diagnosis	5/2
KSBU-N	Kit - Prodigy Smart-Board™ - Network connection	5/2
KVS	Kit - Prodigy Vari-Smart™ Ice Level Control - Adjust ice levels to match ice needs	5/2
KBILC	Kit- Basic Ice Level Control - Thermistor technology, ideal for dispenser applications	
XR-30	XSafe® Sanitation System for Modular Cube - Continuous operation, field-installed	



Scan to View
Current Pricing

Prodigy ELITE® Eclipse® Ice Machines



MC222L



MC330L



MC430L

Cube Size	Model Number	Use With Condensing Unit	24-Hr Ice Production		Unit Dimensions (W x D x H)	Shipping Weight lb/kg	Volts/Hz/Phase 115/60/1 -1
			70°F/21°C 50°F/10°C lb/kg	Air 90°F/32°C Water 70°F/21°C lb/kg			
Sm.	MC222SL	ECC0800 ECC1410	850/386 1030/468	700/318 827/375	22" x 16.5" x 29" 55.9 x 41.9 x 73.7 cm	319/145 332/151	● ●
Sm.	MC330SL	ECC1200	1411/641	1103/500	30" x 24" x 23" 76.2 x 61 x 58.4 cm	310/141	●
Sm./Med.	MC430SL / ML	ECC1410 ECC1800	1425/648 1775/807	1200/545 1600/727	30" x 24" x 29" 76.2 x 61 x 73.7 cm	332/151 350/159	● ●

Features

- Energy efficient components save money on utility costs.
- Better corrosion resistance increases life of unit.
- One piece design makes installation and service easier.
- Maximizes air conditioning load.
- Allows for quiet operation in dining and working environments.
- Able to operate in wide outdoor temperature range from -20° F to 120° F.

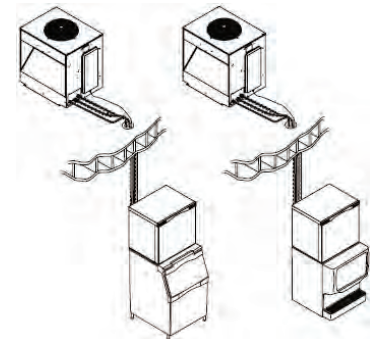

Prodigy Plus® Eclipse Condensing Unit



27" W x 32.06" D x 39.75" H
68.58 x 81.4 x 100.9 cm

Model Number	Description	Shipping Weight lb/kg	Volts/Hz/Phase	
			208-230/60/1 -32	208-230/60/3 -3
Remote Condensers				
ECC0800	Remote condensing unit Eclipse 800 lb/364 kg systems	319/145	●	●
ECC1200	Remote condensing unit Eclipse 1400 lb/636 kg systems	310/141	●	●
ECC1410	Remote condensing unit Eclipse 1000-1400 lb /455-636 kg systems	332/151	●	●
ECC1800	Remote condensing unit Eclipse 1800 lb/818 kg systems	350/159	●	●

Prodigy ELITE® Eclipse® Accessories

Model Number	Description	Shipping Weight lb/kg
Line Sets		
3BRTE20-EH	Line set, 20ft. Refrigerant and Brazing required.	21/10
3BRTE35-EH	Line set, 35ft. Refrigerant and Brazing required.	32/15
3BRTE50-EH	Line set, 50ft. Refrigerant and Brazing required.	53/24
KTE6-EH	Kit, Tube End, 6 Fittings, 3RTExx-EH Line set	5/2

Undercounter Gourmet Cube Units



14.88" W x 22" D x 34.38" H
37.8 x 55.9 x 87.3 cm

Model Number	Condenser Type	24-Hr Ice Production		Storage Capacity lb/kg	Shipping Weight lb/kg	Volts/Hz/Phase 115/60/1 -1
		70°F/21°C 50°F/10°C lb/kg	Air Water 90°F/32°C 70°F/21°C lb/kg			
CU50						
CU50GAX	Air	65/30	49/22	26/12	100/45	●
CU50PAX*	Air	65/30	49/22	26/12	105/48	●

Standard exterior finish: Stainless Steel.
*CU50PAX-1 comes with a pump drain instead of a gravity drain.



18" W x 22" D x 33" H
45.72 x 55.8 x 84 cm

Model Number	Condenser Type	24-Hr Ice Production		Storage Capacity lb/kg	Shipping Weight lb/kg	Volts/Hz/Phase 115/60/1 -1
		70°F/21°C 50°F/10°C lb/kg	Air Water 90°F/32°C 70°F/21°C lb/kg			
UC0918						
UC0918GAX	Air	95/43	78/35	33/15	90/41	●

Standard exterior finish: Stainless Steel.



ESD X identifies models engineered with R290 environmentally friendly refrigerant.
Combine model number and electrical indicator when ordering for exact SKU, i.e. MC0322MAX-1. See page 27 for storage bins.
Please call for pricing on other international configurations.



Scan to View
Current Pricing

Scotsman®

UNDERCOUNTER UNITS



Unit Specific QR Code

Offers quick access to service manuals, cleaning guides, and warranty history directly from the unit.

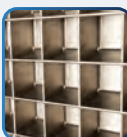

Clear Cube Evaporator Technology

Produces crystal-clear cubes through a unique evaporator design.



Ergonomic Slide-Back Door

Provides smooth, easy access to ice with a convenient slide-back design.

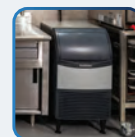

Flexible Placement

Requires no side clearance, allowing easy installation in tight spaces.



ADA Compliant

Supports ADA-compliant installation with an optional floor mount kit.



Small & Medium Cube

Clear, hard ice cubes ideal for restaurants, bars, and beverage service

Small Cube: 7/8" x 7/8" x 3/8"
Medium Cube: 7/8" x 7/8" x 7/8"

Ideal Ice Solutions for Tight Spaces

Ideal for bars, cafés, breakrooms, restaurants, and undercounter applications where cube ice is needed in a space-saving footprint.



Undercounter Cube Ice Machines



CU0415

15" W x 24" D x 38" H*
38.1 x 61 x 96.5 cm



CU0715

15" W x 24" D x 38" H*
38.1 x 61 x 96.5 cm



CU0920

20" W x 24" D x 38" H*
50.8 x 61 x 96.5 cm



UC2024

24" W x 29" D x 39" H*
61 x 73.5 x 99.1 cm



UC2724

24" W x 29" D x 39" H*
61 x 73.5 x 99.1 cm



CU3030

30" W x 30" D x 39" H*
76.2 x 76.2 x 99.1 cm

*Height includes 6" (15.2cm) legs

Cube Size	Model Number	Condenser Type	24-Hr Ice Production		Storage Capacity lb/kg	Shipping Weight lb/kg	Volts/Hz/Phase	
			70°F/21°C 50°F/10°C lb/kg	Air Water			90°F/32°C 70°F/21°C lb/kg	115/60/1 -1
Med.	CU0415MAX	Air	60/27		36/16	90/41	●	
	CU0715MAX	Air	80/36		36/16	96/44	●	
	CU0920MAX	Air	100/46		57/26	118/54	●	
Med.	UC2024MAX	Air	227/103		80/36	150/68	●★	
	UC2024MWX	Water	230/104		80/36	150/68	●	
Sm.	UC2024SAX	Air	227/103		80/36	150/68	●★	
	UC2024SWX	Water	230/104		80/36	150/68	●	
Med.	UC2724MAX	Air	282/128		80/36	175/79	●	
	UC2724MWX	Water	282/128		80/36	175/79	●	
Sm.	UC2724SAX	Air	282/128		80/36	175/79	●	
	UC2724SWX	Water	282/128		80/36	175/79	●	
Med.	CU3030MAX	Air	329/150		110/50	230/104	●	●
Sm.	CU3030SAX	Air	329/150		110/50	230/104	●	●
	CU3030SWX	Water	363/165		110/50	230/104	●	

Undercounter Ice Machine Accessories

Model Number	Description	Shipping Weight lb/kg
KLP85	Kit, Leg 6", Stainless Steel	5/2
KBC1	Kit, Casters	8/4
KUFM15	For ADA applications. Floor mount kit for 15" wide units, lowers overall height to 31.9"	3/1
KUFM20	For ADA applications. Floor mount kit for 20" wide units, lowers overall height to 31.9"	3/1
KUFM24	Floor mount kit for 24" wide units. Lowers height to 33.5"	3/1
KPUFM30	Kit - Prodigy® Undercounter Floor Mount for CU3030	3/1

★ = Energy Star certified.

ESD X identifies models engineered with R290 environmentally friendly refrigerant.

Combine model number and electrical indicator when ordering for exact SKU, i.e. MC0322MAX-1. See page 27 for storage bins. Please call for pricing on other international configurations.



Scan to View
Current Pricing

Scotsman®

PRODIGY® PLUS



AutoAlert™ Panel and QR Code

Visible alerts and quick-access QR code simplify maintenance and service support.



Smart-Board™ and Vari-Smart™

Optional smart alerts, diagnostics, and programmable ice levels help simplify maintenance and keep ice fresh.



Easy-Clean Operation

Removable front air filter, antimicrobial protection, and sealed refrigeration system support cleaner operation.



F0522 on B322S



Sealed Maintenance-Free Bearings

Eliminates the need for greasing while helping improve reliability and reduce downtime.



Stainless Steel Components

Stainless steel evaporator and auger are built for long-lasting durability.



Flake Ice

Soft, slow-melting ice ideal for displays, preservation, blended beverages, and therapeutic use.

Size: Compressed Ice

Versatile Flake Ice for Cooling, Display & Blending

Soft, slow-melting flake ice molds easily, cools quickly, and performs across food, beverage, and therapeutic applications.

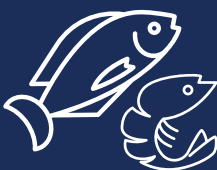

Seafood Displays



Produce



Meat



Blended Cocktails



Therapeutic Use

Prodigy Plus® Modular Flake Ice Machines

*Refer to page 27 & 29 for required bins & bin top kits.



22" W x 24" D x 23" H
55.9 x 61 x 58.4 cm

Model Number	Condenser Type	24-Hr Ice Production			Shipping Weight lb/kg	Volts/Hz/Phase	
		70°F/21°C 50°F/10°C lb/kg	Air Water	90°F/32°C 70°F/21°C lb/kg		115/60/1 -1	208-230/60/1 -32
F0522							
FS0522AX	Air	450/204		344/156	173/78	●★	
FS0522WX	Water	521/237		386/176	173/78	●	
F0822							
FS0822AX	Air	800/363		606/275	175/79	●★	
FS0822R	Remote	760/345		589/267	175/79	●	
FS0822WX	Water	775/352		581/264	175/79	●	●



22" W x 24" D x 27" H
55.9 x 61 x 68.6 cm

Model Number	Condenser Type	24-Hr Ice Production			Shipping Weight lb/kg	Volts/Hz/Phase	
		70°F/21°C 50°F/10°C lb/kg	Air Water	90°F/32°C 70°F/21°C lb/kg		208-230/60/1 -32	208-230/60/3 -3
F1222							
FS1222AX	Air	1056/480		827/376	220/100	●★	
FS1222R	Remote	1250/567		875/397	220/100	●	●
FS1222WX	Water	1010/459		933/424	220/100	●	
F1522							
FS1522AX	Air	1514/688		1095/498	224/102	●★	



30" W x 24" D x 29" H
76.2 x 61 x 73.7 cm

Model Number	Condenser Type	24-Hr Ice Production			Shipping Weight lb/kg	Volts/Hz/Phase	
		70°F/21°C 50°F/10°C lb/kg	Air Water	90°F/32°C 70°F/21°C lb/kg		208-230/60/1 -32	208-230/60/3 -3
F2330							
FS2330R	Remote	2218/1006		1861/844	335/152	●	●
FS2330W	Water	2405/1091		2041/926	335/152	●	●



40" W x 24" D x 27" H
106.7 x 61 x 68.6 cm

Model Number	Condenser Type	24-Hr Ice Production			Shipping Weight lb/kg	Volts/Hz/Phase	
		70°F/21°C 50°F/10°C lb/kg	Air Water	90°F/32°C 70°F/21°C lb/kg		208-230/60/1 -32	
FME2404							
FME2404AS	Air	2455/1114		1792/813	395/179		●

★ = Energy Star certified.

ECO X identifies models engineered with R290 environmentally friendly refrigerant. Combine model number and electrical indicator when ordering for exact SKU, i.e. MC0322MAX-1. See page 27 for storage bins. Please call for pricing on other international configurations.



Scan to View
Current Pricing

Scotsman®

PRODIGY PLUS



AutoAlert™ Panel and QR Code

Visible alerts and quick-access QR code simplify maintenance and service support.



Smart-Board™ and Vari-Smart™

Optional smart alerts, diagnostics, and programmable ice levels help simplify maintenance and keep ice fresh.



Easy-Clean Operation

Removable front air filter, antimicrobial protection, and sealed refrigeration system support cleaner operation.



N0422 on IOD150



Sealed Maintenance-Free Bearings

Eliminates the need for greasing while helping improve reliability and reduce downtime.



Stainless Steel Components

Stainless steel evaporator and auger are built for long-lasting durability.



Nugget Ice

Available in softer Original Chewable Nugget Ice® or harder H² Nugget Ice.

Soft: 7/16" x 5/16" x 3/8"

Hard: 3/4" x 5/16" x 3/8"

Why Choose Nugget Ice Over Cube Ice?



of Customers Prefer Nugget Ice with Soft Drinks



Less Water Used By Nugget Ice*



More Profitability with Higher Displacement, Using Less Syrup/Beverage*

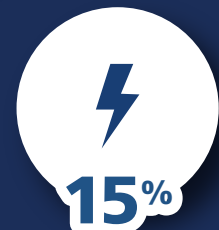

Less Energy Used By Nugget Ice*

*Compared to Cube Ice. Values are Approximate and May Vary.

Prodigy Plus® Modular Nugget Ice Machines

*Refer to page 27 & 29 for required bins & bin top kits.



22" W x 24" D x 23" H
55.9 x 61 x 58.4 cm

Nugget Type	Model Number	Condenser Type	24-Hr Ice Production		Shipping Weight lb/kg	Volts/Hz/Phase	
			70°F/21°C 50°F/10°C lb/kg	Air Water 70°F/21°C lb/kg		90°F/32°C 70°F/21°C lb/kg	115/60/1 -1

N0422

Hard	NH0422AX	Air	375/170		172/78	●★
	NH0422WX	Water	444/202	285/130 287/130	172/78	●
Soft	NS0422AX	Air	430/191		172/78	●★
	NS0422WX	Water	455/206	327/149 308/140	172/78	●

N0622

Hard	NH0622AX	Air	644/292		180/82	●★
	NH0622R	Remote	631/286	466/211 549/249	180/82	●
	NH0622WX	Water	640/290	505/229	180/82	●
Soft	NS0622AX	Air	664/302		180/82	●★
	NS0622R	Remote	660/299	471/214 579/263	180/82	●
	NS0622WX	Water	715/325	515/234	180/82	●



22" W x 24" D x 27" H
55.9 x 61 x 68.6 cm

Nugget Type	Model Number	Condenser Type	24-Hr Ice Production		Shipping Weight lb/kg	Volts/Hz/Phase	
			70°F/21°C 50°F/10°C lb/kg	Air Water 70°F/21°C lb/kg		90°F/32°C 70°F/21°C lb/kg	115/60/1 -1

N0922

Hard	NH0922AX	Air	862/392		210/95	●★	●★
	NH0922R	Remote	896/406	695/316 758/344	210/95	●	●
	NH0922WX	Water	908/412	787/357	210/95	●	●
Soft	NS0922AX	Air	956/438		210/95	●★	●★
	NS0922R	Remote	1044/474	707/321 781/352	210/95	●	●
	NS0922WX	Water	1094/496	863/389	210/95	●	●

N1322

Hard	NH1322AX	Air	1199/545		225/102	●★	●★
	NH1322R	Remote	1191/540	913/415 1000/455	225/102	●	●
	NH1322WX	Water	1155/525	966/439	225/102	●	●
Soft	NS1322AX	Air	1314/597		225/102	●★	●★
	NS1322R	Remote	1360/618	1001/455 1077/489	225/102	●	●
	NS1322WX	Water	1484/675	1043/474	225/102	●	●



30" W x 24" D x 29" H
76.2 x 61 x 73.7 cm

Nugget Type	Model Number	Condenser Type	24-Hr Ice Production		Shipping Weight lb/kg	Volts/Hz/Phase	
			70°F/21°C 50°F/10°C lb/kg	Air Water 70°F/21°C lb/kg		90°F/32°C 70°F/21°C lb/kg	208-230/60/1 -32

N2030

Hard	NH2030R	Remote	1806/819		337/153	●	●
	NH2030W	Water	2003/909	1555/705 1723/782	337/153	●	●
Soft	NS2030R	Remote	1886/855		337/153	●	●
	NS2030W	Water	2121/962	1618/734 1781/808	337/153	●	●

★ = Energy Star certified.

ECO X identifies models engineered with R290 environmentally friendly refrigerant.
Combine model number and electrical indicator when ordering for exact SKU, i.e. MC0322MAX-1. See page 27 for storage bins.
Please call for pricing on other international configurations.



Scan to View
Current Pricing

Prodigy Plus® Remote Low Side Nugget & Flake Complete Packages



22" W x 24" D x 27" H
55.9 x 61 x 68.6 cm



30" W x 24" D x 29" H
76.2 x 61 x 73.7 cm



22" W x 24" D x 27" H
55.9 x 61 x 68.6 cm

Ice Form	Model Number	24-Hr Ice Production		Shipping Weight lb/kg	Volts/Hz/Phase 115/60/1 -1
		70°F/21°C 50°F/10°C lb/kg	Air Water		

FS1222L / FS1522L

Flake	FS1222L	1180/535		217/98	●
Flake	FS1522L	1445/655		224/102	●

Ice Form	Model Number	24-Hr Ice Production		Shipping Weight lb/kg	Volts/Hz/Phase 208-230/60/1 -32
		70°F/21°C 50°F/10°C lb/kg	Air Water		

FS2330L

Flake	FS2330L	2275/1032		233/106	●
-------	---------	-----------	--	---------	---

Nugget Type	Model Number	24-Hr Ice Production		Shipping Weight lb/kg	Volts/Hz/Phase 115/60/1 -1
		70°F/21°C 50°F/10°C lb/kg	Air Water		

N0922L / N1322L

Hard	NH0922L	889/403		217/98	●
	NH1322L	1191/540		225/102	●
Soft	NS0922L	1090/494		217/98	●
	NS1322L	1330/603		225/102	●



FLAKE

Flake ice is a smart choice for everything from blended cocktails and salad bars to produce, seafood and meat displays. It is also a popular choice for therapeutic use in healthcare facilities.



NUGGET

Our original Nugget ice is the best choice for carbonated beverages and therapeutic use. The H² Nugget allows for better dispensing and also melts slower.

Nugget & Flake Ice Machine Kits and Accessories

Model Number	Description	Unit Dimensions (W x D x H)	Shipping Weight lb/kg	Volts/Hz/Phase		
				115/60/1 -1	208-230/60/1 -32	230/50/1 -6
Remote Condensers						
ERC111	Remote condenser for F0822R, N0622R or N0922R-1	29.5" x 29.13" x 38.47" 74.9 x 74.0 x 97.7 cm	95/43	●		
ERC311	Remote condenser for F1222R, F1522R, N0922R-32 or N1322R	29.5" x 29.13" x 38.47" 74.9 x 74.0 x 97.7 cm	130/59		●	●
ERC611	Remote condenser for F2330R and N2030R	29.5" x 37.8" x 38.47" 74.9 x 96.0 x 97.7 cm	140/84		●	

Model Number	Description	Shipping Weight lb/kg
Line Sets		
BRTE10	Line set, 10 ft, brazing required	7/3
BRTE25	Line set, 25 ft, brazing required	12/5
BRTE40	Line set, 40 ft, brazing required	17/7
BRTE75	Line set, 75 ft, brazing required	35/15
KTE4	Tube end kit - Contains 4 quick connect fittings for any RTE Line Set	5/2

Miscellaneous		
KERCF	Air filter for ERC111 or ERC311	5/2
KPFHM-E	Headmaster Kit for use with ERC101, ERC151, ERC201, ERC302 or PR2C240; Quick connect not included	10/5
KCMR-230	Fan relay kit for two 230V units connected to PR2C240 condenser	5/2

Prodigy Modular Flake & Nugget Accessories		
KPAS	Kit-Prodigy Advanced Sustainability. Includes KSBU-N and KVS	10/4
KSBU	Kit-Prodigy Smart-Board™ - Use additional operational data for fast diagnosis	5/2
KSBU-N	Kit-Prodigy Smart-Board™ - Network connection	5/2
KVS	Kit-Prodigy Vari-Smart™ Ice Level Control - Adjust ice levels to match ice needs	5/2

Remote Low Side Nugget & Flake Accessories		
NRTE45	45 ft. (13.7 m) non-precharged line set for remote low side flaker and nugget ice machines	17/8



★ = Energy Star certified.
 E60 X identifies models engineered with R290 environmentally friendly refrigerant.
 Combine model number and electrical indicator when ordering for exact SKU, i.e. MC0322MAX-1. See page 27 for storage bins.
 Please call for pricing on other international configurations.



Scan to View
Current Pricing

Scotsman®

UNDERCOUNTER UNITS



Unit Specific QR Code

Offers quick access to service manuals, cleaning guides, and warranty history directly from the unit.



Sealed Maintenance-Free Bearings

Eliminates the need for greasing while helping improve reliability and reduce downtime.



Ergonomic Slide-Back Door

Provides smooth, easy access to ice with a convenient slide-back design.



UN0815, UF0915,
UN1215, UF1415

UN1520, UF2020



Flexible Placement

Requires no side clearance, allowing easy installation in tight spaces.



ADA Compliant

Supports ADA-compliant installation with an optional floor mount kit.



Nugget or Flake Ice

Choose from chewable nugget ice or soft flake ice for drinks, displays, preservation, and cooling.

Nugget: 7/16" x 5/16" x 3/8"
Flake: Compressed Ice

Ideal Ice Solutions for Tight Spaces

Ideal for bars, cafés, breakrooms, restaurants, and undercounter applications where nugget or flake ice is needed in a space-saving footprint.



Undercounter Nugget and Flake Ice Machines



UN0815
15" W x 24" D x 38" H*
38.1 x 61 x 96.5 cm



UN1215
15" W x 24" D x 38" H*
38.1 x 61 x 96.5 cm



UN1520
20" W x 24" D x 38" H*
50.8 x 61 x 96.5 cm



UN324
24" W x 28.5" D x 39" H*
61 x 72.4 x 99.1 cm



UF0915
15" W x 24" D x 38" H*
38.1 x 61 x 96.5 cm



UF1415
15" W x 24" D x 38" H*
38.1 x 61 x 96.5 cm



UF2020
20" W x 24" D x 38" H*
50.8 x 61 x 96.5 cm



UF424
24" W x 28.5" D x 39" H*
61 x 72.4 x 99.1 cm

*Height includes 6" (15.2cm) legs

Ice Form	Model Number	Condenser Type	24-Hr Ice Production		Storage Capacity lb/kg	Shipping Weight lb/kg	Volts/Hz/Phase 115/60/1 -1
			70°F/21°C 50°F/10°C lb/kg	Air Water			
Nugget	UN0815AX	Air	99/45		36/16	108/49	●
	UN1215AX	Air	129/59		36/16	109/49	●
	UN1520AX	Air	167/76		57/26	129/59	●
	UN324AX	Air	340/154		80/36	210/95	●★
	UN324WX	Water	340/154		80/36	210/95	●
Flake	UF0915AX	Air	96/44		36/16	108/49	●
	UF1415AX	Air	142/64		36/16	109/49	●
	UF2020AX	Air	216/98		57/26	129/59	●
	UF424AX	Air	440/200		80/36	200/91	●
	UF424WX	Water	479/218		80/36	200/91	●

Undercounter Ice Machine Accessories

Model Number	Description	Shipping Weight lb/kg
KLP85	Kit, Leg 6", Stainless Steel	5/2
KBC1	Kit, Casters	8/4
KUFM15	For ADA applications. Floor mount kit for 15" wide units, lowers overall height to 31.9"	3/1
KUFM20	For ADA applications. Floor mount kit for 20" wide units, lowers overall height to 31.9"	3/1
KUFM24	Floor mount kit for 24" wide units. Lowers height to 33.5"	3/1

★ = Energy Star certified.

eco identifies models engineered with R290 environmentally friendly refrigerant.

Combine model number and electrical indicator when ordering for exact SKU, i.e. MC0322MAX-1. See page 27 for storage bins. Please call for pricing on other international configurations.



Scan to View
Current Pricing

Scotsman®

meridian

ICE AND WATER DISPENSERS



AutoAlert™ Indicator Panel

Intuitively displays relevant machine status that is visible across the room.



Easily Removable Components

Fully removable air filter, spouts, sink, grill, and bin allow for easy cleaning and maintenance.



UV-LED Sanitation

Internal UV module actively treats incoming water to ensure clean, refreshing ice and water.



Maximum Uptime

Integrated drain cover and consolidated drain ensures reliable operation.



ADA Compliant Dispensing Area

Touch-free and push-button models meet ADA reach range requirements.



HID207

HID312



Original, Chewable Nugget Ice®

Preferred by customers and originally produced by Scotsman in 1981.

Compact Refreshment for Any Shared Space

Scotsman HID countertop dispensers deliver chewable nugget ice and refreshing water in a space-saving design ideal for offices, breakrooms, hospitality areas, and guest spaces.



Ice and Water Dispensers



HID207
HID207AX & HID207ABX
 16.05" W x 23.44" D x 17.54" H
 40.7 x 59.5 x 44.5 cm



HID312
HID312AX & HID312ABX
 16.25" W x 24.38" D x 35" H
 41.28 x 61.93 x 88.9 cm
HID312AWX
 18.25" W x 24.38" D x 35" H
 46.36 x 61.93 x 88.9 cm



HID525
HID525AX & HID525ABX
HID525WX & HID525WBX
 21.25" W x 24.38" D x 35" H
 54 x 61.93 x 88.9 cm
HID525AWX
 23.25" W x 24.38" D x 35" H
 59.06 x 61.93 x 88.9 cm



HID540
HID540AX & HID540ABX
HID540WX & HID540WBX
 21.25" W x 24.38" D x 41" H
 54 x 61.93 x 104.14 cm
HID540AWX
 23.25" W x 24.38" D x 41" H
 59.06 x 61.93 x 104.14 cm

Model Number	Condenser Type	Dispensing Method	24-Hr Ice Production		Storage Capacity lb/kg	Shipping Weight lb/kg	Volts/Hz/Phase 115/60/1 -1
			70°F/21°C 50°F/10°C lb/kg	Air Water 90°F/32°C 70°F/21°C lb/kg			
HID207AX	Air	Touch-Free Sensor	196/89	160/72	7/3.17	80/36.3	●
HID207ABX	Air	Button Activated	196/89	160/72	7/3.17	80/36.3	●
HID312AX	Air	Touch-Free Sensor	320/145	245/111	12/5	183/83	●
HID312ABX	Air	Button Activated	320/145	245/111	12/5	183/83	●
HID312AWX*	Air	Touch-Free Sensor	320/145	245/111	12/5	188/85	●
HID525AX	Air	Touch-Free Sensor	500/227	380/166	25/11	208/94	●
HID525ABX	Air	Button Activated	500/227	380/166	25/11	208/94	●
HID525AWX*	Air	Touch-Free Sensor	500/227	380/166	25/11	213/97	●
HID525WX	Water	Touch-Free Sensor	500/227	400/181	25/11	208/94	●
HID525WBX	Water	Button Activated	500/227	400/181	25/11	208/94	●
HID540AX	Air	Touch-Free Sensor	500/227	380/166	40/18	215/98	●
HID540ABX	Air	Button Activated	500/227	380/166	40/18	215/98	●
HID540AWX*	Air	Touch-Free Sensor	500/227	380/166	40/18	220/100	●
HID540WX	Water	Touch-Free Sensor	500/227	400/181	40/18	215/98	●
HID540WBX	Water	Button Activated	500/227	400/181	40/18	215/98	●

*Wall mount configuration. Does not have drip tray. Designed to be installed over existing sink.

Ice and Water Dispenser Stands and Accessories



HSTCD16-A
 16.5" W x 23.56" D x 32" H*
 41.9 x 59.8 x 81.3 cm*



HST16-A
 16.5" W x 23.75" D x 32" H*
 41.9 x 60.3 x 81.3 cm*



HST16B-A
 16.5" W x 23.75" D x 32" H*
 41.9 x 60.3 x 81.3 cm*



HST21-A
 21.5" W x 23.75" D x 32" H*
 54.6 x 60.3 x 81.3 cm*



HST21B-A
 21.5" W x 23.75" D x 32" H*
 54.6 x 60.3 x 81.3 cm*
 *Height includes 6" (15.2cm) legs

Model Number	Description	Shipping Weight lb/kg
HSTCD16-A	Stand with door, use with HID207, includes 6" legs	55/25
HST16-A	Stand with door, use with HID312, SS, includes 6" legs	50/23
HST16B-A	Stand for HID312, basic version, SS, includes 6" legs	50/23
HST21-A	Stand with door, use with HID525 & HID540, SS, includes 6" legs	80/36
HST21B-A	Stand for HID525 & HID540, basic version, SS, includes 6" legs	80/36
KLP24A	4" adjustable legs, plastic with metal foot (box of 4)	5/2

★ = Energy Star certified.

X identifies models engineered with R290 environmentally friendly refrigerant. Combine model number and electrical indicator when ordering for exact SKU, i.e. MC0322MAX-1. See page 27 for storage bins. Please call for pricing on other international configurations.



Scan to View
 Current Pricing

Hotel / Motel Cube Dispensers



22" x 33.5" x 53.25"*
55.9 x 85.1 x 135.3 cm*

Model Number	Dispensing Method	Storage Capacity lb/kg	Shipping Weight lb/kg	Volts/Hz/Phase	
HD22					
HD22B	Lever Activated	120/59	201/91	●	●
HD22W	Water Filler	120/59	201/91	●	



30" x 33.5" x 53.25"*
76.2 x 85.1 x 135.3 cm*

Model Number	Dispensing Method	Storage Capacity lb/kg	Shipping Weight lb/kg	Volts/Hz/Phase	
HD30					
HD30B	Lever Activated	180/81	220/100	●	●
HD30W	Water Filler	180/81	225/102	●	

*Height includes 6" (15.2cm) legs

Hotel / Motel Cube Dispenser Accessories

Model Number	Description	Unit Dimensions (W x D x H)	Shipping Weight lb/kg
KHDSANLV	Sanitary level kit for HD models	12" x 6" x 6" 30.5 x 15.2 x 15.2 cm	5/2

Ice Only Counter Top Dispensers



IOD150
23" W x 31" D x 35" H
58.42 x 78.74 x 88.9 cm



IOD200
30" W x 31" D x 35" H
76.2 x 78.74 x 88.9 cm



IOD250
30" W x 31" D x 41" H
76.2 x 78.74 x 104.14 cm

Model Number	Dispensing Method	Storage Capacity lb/kg	Shipping Weight lb/kg	Volts/Hz/Phase
IOD150	Lever Activated	150/68	185/84	●
IOD150WF*	Lever Activated	150/68	185/84	●
IOD200	Lever Activated	200/91	235/106	●
IOD200WF*	Lever Activated	200/91	235/106	●
IOD250	Lever Activated	250/114	260/118	●
IOD250WF*	Lever Activated	250/114	260/118	●

*WF models include a factory installed water fill lever.

★ = Energy Star certified.

ECO X identifies models engineered with R290 environmentally friendly refrigerant.

Combine model number and electrical indicator when ordering for exact SKU, i.e. MC0322MAX-1. See page 27 for storage bins. Please call for pricing on other international configurations.

Ice Only Dispenser Kits and Accessories



Model Number	Description	Unit Dimensions (W x D x H)	Shipping Weight lb/kg
Machine Stands			
IODST22	Machine stand for IOD150	22" x 29" x 30" 55.9 x 73.7 x 76.2 cm*	105/47
IODST30	Machine stand for IOD200 & IOD250	30" x 29" x 30" 76.2 x 73.7 x 76.2 cm*	110/49
Kits			
KNUGAGT	Field installed agitator kit for IOD150, IOD200, & IOD250 when used for nugget ice applications		10/5

*Height includes 6" (15.2cm) legs

Storage Bins



Model Number	Storage Capacity lb/kg	Ext. Finish	Liner Material	Unit Dimensions (W x D x H)	Shipping Weight lb/kg
Modular Bins					
B322S	370/168	Metallic	Poly	22" x 34" x 50" 55.9 x 86.4 x 127 cm*	140/64
B330P	344/156	Poly	Poly	30" x 34" x 37" 76.2 x 86.4 x 94 cm*	90/41
B530P	536/244	Poly	Poly	30" x 34" x 50" 76.2 x 86.4 x 127 cm*	110/50
B530S	536/244	Metallic	Poly	30" x 34" x 50" 76.2 x 86.4 x 127 cm*	150/68
B842S	778/353	Metallic	Poly	42" x 34" x 37" 106.7 x 86.4 x 94 cm*	190/86
B948S	893/406	Metallic	Poly	48" x 34" x 50" 121.9 x 86.4 x 127 cm*	209/95

*Height includes 6" (15.2cm) legs



Model Number	Storage Capacity lb/kg	Ext. Finish	Liner Material	Unit Dimensions (W x D x H)	Shipping Weight lb/kg
BL Upright Modular Bins					
BL1048S	1000/454	Stainless Steel	Poly	48" x 31" x 54.4" 121.9 x 78.7 x 138.2 cm*	268/122
BL1360S	1320/599	Stainless Steel	Poly	60" x 31" x 54.4" 152.4 x 78.7 x 138.2 cm*	322/147
BL1660S	1660/753	Stainless Steel	Poly	60" x 31" x 63.4" 152.4 x 78.7 x 161 cm*	340/154

BL bins include universal adapter plate for use with most ice machines. See machine bin sizing chart on pages 34-35 for special configurations.

*Height includes 6" (15.2cm) legs



Scan to View
Current Pricing

Ice Express System (Built-to-Order Only)



Model Number	Description	Storage Capacity lb/kg	Ext. Finish	Liner Material	Unit Dimensions (W x D x H)	Shipping Weight lb/kg
Ice Express System						
ICS730	1 Bay*	652/296	Stainless Steel	Poly	31" x 40" x 75" 78.7 x 101.6 x 190.5 cm*	398/181
ICS1360	2 Bay*	1327/603	Stainless Steel	Poly	60" x 40" x 75" 152.4 x 101.6 x 190.5 cm*	712/323
ICS1790	3 Bay*	1716/779	Stainless Steel	Poly	90" x 40" x 70" 228.6 x 101.6 x 177.8 cm*	978/444

Options

ICS-PADDLE	Replacement paddle, white plastic	N/A	Poly	N/A		9/4
ICS-SHOVEL	Shovel, white plastic	N/A	Poly	N/A		9/4
ICS-CP	Replacement Poly Cart	240/109	Poly	N/A		75/34
ICS-TOTE	Ice Totes - Set of 6	150/68	Poly	N/A		34/15

* Includes 1 poly cart for each bay.

Bin Accessories

Model Number	Description	Shipping Weight lb/kg
Caster Kits		
KBC1	Bin caster kit for B530S, B842S, B948S, SB480, UC2024, UC2724, CU3030, BH bins, UF & UN Undercounter models [3.5" (8.9 cm) diameter wheels, 2 standard wheels and 2 locking. Raises bin 4 7/16" (11.3 cm)] - Not to be used with SB480 when using extension or B222S or B322S.	8/4
KBC1P	Bin caster kit for B330P and B530P. [3.5" (8.9 cm) diameter wheels, 2 standard wheels and 2 locking. Raises bin a maximum of 4 7/16" (11.3 cm).	20/9
Leg Kits		
KLP7	Kit, legs, 6" black enamel, flanged feet, B Bins, HST stands, HD dispensers, CU0515, UC2024, UC2724, CU3030, UF & UN Undercounter models.	5/2
KLP8S	Kit, legs, 6" stainless steel, Bx22, Bx30, B842, B948, HST stands, HD dispensers CU1526, CU2026, CU3030, UF & UN Undercounter models. Note: Legs are supplied with self-contained machines, bins and machine stands.	5/2
Ice Bagger		
BGS10	Hooks over any ice bin opening. Aluminum. Note: BGS10 includes easy bagger, wicket of bags (250), tape sealer and 1 roll of tape.	25/11
KBAG	Case of 1000 8lb bags.	30/14
KTAPE	One roll - 180 ft (54.9 m)	1/0.5
KSEALER	Tape sealer.	5/2
Ice Scoop Holder		
KHOLDER	Stainless steel scoop holder. Fits all B330, B530, B842 and B948 ice storage bins	2/1



19.25" W x 10.75" D x 28.5" H
48.9 x 27.3 x 72.4 cm

Bin Top Kits

Model Number	Description	Use On	Shipping Dimensions (L x W x H)	Shipping Weight lb/kg
KBT14A	NME1854, FME2404	B948	10" x 27" x 5" 25.4 x 68.6 x 12.7 cm	8/4
KBT22B	All 30" (76.2 cm) modular cube, flake or nugget ice makers	B948	17" x 29" x 5" 43.2 x 68.6 x 12.7 cm	11/5
KBT27	All 22" (55.9 cm) modular cube, flake or nugget ice makers except MC222L	B330, B530	10" x 27" x 5" 25.4 x 68.6 x 12.7 cm	8/4
KBT29	All 30" (76.2 cm) modular cube, flake or nugget ice makers	B842	14" x 27" x 7" 35.6 x 68.6 x 17.8cm	10/5
KBT31	MC222L	B322	10" x 27" x 5" 25.4 x 68.6 x 12.7 cm	8/4
KBT38	All 22" (55.9 cm) modular cube, flake and nugget ice makers except MC222L	B948	6" x 30" x 17" 15.2 x 76.2 x 43.2 cm	14/7
KBT38-2X	All 22" (55.9 cm) modular cube, flake or nugget ice makers except MC222L side by side	B948	10" x 27" x 5" 25.4 x 68.6 x 12.7 cm	5/2
KBT39	All 22" (55.9 cm) modular cube, flake and nugget ice makers except MC222L	B842	14" x 27" x 7" 35.6 x 68.6 x 17.8cm	10/5
KBTABS	MC222L	ABS	26" x 24" x 7" 66 x 61 x 17.8 cm	24/11
KBT80	MC222L	IOD150	26" x 24" x 7" 66 x 61 x 17.8 cm	24/11
KBT81	MC222L	IOD200, IOD250	32" x 32" x 5" 81.3 x 81.3 x 12.7 cm	25/11
KBT82	All 22" (55.9 cm) modular ice machines except MC222L	IOD150	31" x 33" x 5" 78.7 x 83.8 x 12.7 cm	12/5
KBT83	All 22" (55.9 cm) modular cube and nugget ice makers except MC222L	IOD200, IOD250	33" x 47" x 5" 83.8 x 119.4 x 12.7 cm	26/12
KBT84	All 30" (76.2 cm) modular cube ice makers	IOD200, IOD250	32" x 33" x 2" 1.3 x 83.8 x 5.1 cm	13/5
KBT45	MC222L	ED300	32" x 31" x 5" 81.3 x 78.7 x 12.7 cm	33/15

Bin Top Kits - BL1048, BL1360, BL1660, ICS

KBT70	Kit, Bin top for use with (2) 30" (76.2 cm) heads on BL1360 or BL1660	BL1360, BL1660	36" x 63" x 5" 91.4 x 160 x 12.7 cm	70/32
KBT71	Kit, Bin top for use with 22" (55.9 cm) MC222L head on BL1048	BL1048	36" x 63" x 5" 91.4 x 160 x 12.7 cm	70/32
KBT72	Kit, Bin top for use with (2) MC222L on BL1048	BL1048	36" x 63" x 5" 91.4 x 160 x 12.7 cm	70/32
KBT73	Kit, Bin top for use with MC222L on BL1360, BL1660	BL1360, BL1660	36" x 63" x 5" 91.4 x 160 x 12.7 cm	70/32
KBT74	Kit, Bin top for use with (2) MC222L on BL1360 or BL1660	BL1360, BL1660	36" x 63" x 5" 91.4 x 160 x 12.7 cm	70/32
KBT75	Kit, Bin top for use with (2) 30" (76.2 cm) heads on ICS1360	ICS1360	36" x 63" x 5" 91.4 x 160 x 12.7 cm	70/32

Accessory Kits

Model Number	Description	Shipping Weight lb/kg
Prodigy Plus® Nugget Dispenser Accessory Kits		
KDIL-PN-150	Kit, Ice Level Control with KVS, Prodigy Nugget on Cornelius DF or ED150	2/1
KDIL-PN-200	Kit, Ice Level Control with KVS, Prodigy Nugget on Cornelius DF or ED200	5/2
KDIL-PN-250	Kit, Ice Level Control with KVS, Prodigy Nugget on Cornelius DF or ED250	5/2
KDIL-PN-ID3	Kit, Ice Level Control with thermostat, Prodigy Nugget on Cornelius DF or ED300	2/1
KFSMF	Kit, manual fill nugget for Coca Cola Freestyle 9000 dispenser	3/1
KFSTM	Kit, top mounted nugget for Coca Cola Freestyle 9000 dispenser	3/1
KFS-LTP	Kit, Coca Cola Freestyle 9000 dispenser and Lancer TwinPour	5/2



Scan to View
Current Pricing

XSafe® Sanitation System



Our XSafe® device is an optional sanitation system that is integrated on the top of your ice machine. XSafe® circulates cold oxygen plasma inside of the machine to help sanitize the air and surrounding surfaces. Operating automatically, this sanitation system runs all day long to ensure your equipment is clean and safe.



Model Number	Description	Unit Dimensions (W x D x H)	Shipping Weight lb/kg
XSafe® Sanitation System			
XR-30	Sanitation system for helping eliminate viruses, bacteria and slime. Compatible with all modular units.	12" x 4.25" x 2.25" 30.5 x 10.8 x 5.7 cm	10/5

AquaDefense® System - Sanitation Solution



Model Number	Description	Unit Dimensions (W x D x H)	Shipping Weight lb/kg
AquaBullet® Anti Microbial Wand			
ADS-AB6	6 pack of Antimicrobial wands to prevent slime and mold build up. Used for modular cube ice machines.		5/2



Model Number	Description	Unit Dimensions (W x D x H)	Shipping Weight lb/kg
AquaPatrol™ Plus Water Filtration System			
AP1-P	Single system – Cubers up to 650 lb (395 kg), flakers, nuggets and nugget dispensers up to 1,200 lb (544 kg)	5.625" x 4.75" x 21.5" 14.3 x 12.1 x 54.6 cm	7/3
AP2-P	Twin System – Cubers over 650 lb (395 kg) and up to 1,200 lb (544 kg), flakers and nuggets over 1,200 lb (544 kg)	16.5" x 5.5" x 19.25" 41.9 x 14 x 48.9 cm	11/5
AP3-P	Triple System – Cubers over 1,200 lb (544 kg)	21 x 5.5 x 19.25" 53.3 x 14 x 48.9 cm	16/7
APRC1-P	Replacement cartridge (package of 1)		3/1.5
APRC6-P	Replacement cartridge (package of 6)		7/3

Water Filtration Systems By Everpure®



Model Number	Description	Unit Dimensions (W x D x H)	Shipping Weight lb/kg
SSM Plus Filtration Systems with AquaArmor by AgION®			
SSM1-P	Single system - Cubers up to 650 lb (395 kg), flakers, nuggets and nugget dispensers up to 1,200 lb (544 kg)	5.625 x 4.75 x 30.5 14.3 x 12.1 x 77.5 cm	7/3
SSM2-P	Twin System - Cubers over 650 lb (295 kg), flakers and nuggets over 1,200 lb (544 kg)	16.5 x 5.5 x 29.25 41.9 x 14 x 74 cm	11/5
SSM3-P	Triple System - Cubers over 1,200 lb (544 kg)	21 x 5.5 x 29.25 53.3 x 14 x 74 cm	16/7
SSMRC Replacement Cartridges			
SSMRC1	Single replacement cartridge (package of 1)		3/1.5
SSMRC6	6 pack replacement cartridge (package of 6)		7/3
SC Coarse Prefilters			
SC10-A	10" (25.4 cm) Coarse prefilter		5/2
SC20-A	20" (50.8 cm) Coarse prefilter		11/5
SC Replacement Prefilters			
SC10RC40	SC10 replacement filter		17/8
SC20RC20	SC20 replacement filter		17/8

Water Filter Selection

Ice Form	Configuration	Model Number	AquaPatrol (System, Cartridge)	SSM Plus (System, Cartridge)
Cube	Self-Contained	CU50, CU0415, CU0715, UC0918, CU0920, UC2024, UC2724, CU3030	AP1-P, APRC1-P	SSM1-P, SSMRC1
Cube	Up to 650 lbs	MC0322, MC0330, MC0522, MC0530, MC0630, MC0722	AP1-P, APRC1-P	SSM1-P, SSMRC1
Cube	Up to 1,200 lbs	MC0830, MC1030, MC222L	AP2-P, APRC1-P	SSM2-P, SSMRC1
Cube	Over 1,200 lbs	MC1448, MC1848, MC2148, MC2648, MC330L, MC430L	AP3-P, APRC1-P	SSM3-P, SSMRC1
Nugget/Flake	Self-Contained/ Dispenser	HID207, HID312, HID525, HID540, UF0915, UF1415, UF424, UN0815, UN1215, UN324	AP1-P, APRC1-P	SSM1-P, SSMRC1
Nugget/Flake	Up to 1,200 lbs	F0522, F0822, F1222, N0422, N0622, N0922	AP1-P, APRC1-P	SSM1-P, SSMRC1
Nugget/Flake	Over 1,200 lbs	F1522, F2330, FME2404, N1322, N2030	AP2-P, APRC1-P	SSM2-P, SSMRC1



Scan to View
Current Pricing

Charts & Index

ICE MACHINE TO DISPENSER KIT CHART	33
MACHINE / BIN SIZING CHART	34-35
INDEX	36-38
WARRANTY & DEFINITIONS	39



Ice Machine to Dispenser Kit Application Chart

Company	Dispenser	Ice Machines MC222L	MC0322/522/722	MC0330/530/630/ 830/1030/330L/430L	N0422/622/ 922/1322
Cornelius	ED150	620201029*	620201013TE*		620201013TE* KDIL-PN-150
Cornelius	DF150	629087959*	02388*		02388* KDIL-PN-150
Cornelius	ED175	629087571*	629093782TE*		KDIL-PN-150 629093782TE*
Cornelius	ED200	620201028*	620201015TE*	620201017TE*	620201015TE* KDIL-PN-200
	DF200	629087572*	08035*	08004*	
Cornelius	ED250	620201028*	620201015TE*	620201017TE, KBILC**	620201015TE* KDIL-PN-250
	DF250	629087572*	08035*	08004*, KBILC**	
Cornelius	ED300	KBT45	08028*	629087943*	KDIL-PN-ID3 629087966* 629088644*
	DF300	KBT45	08028*	629087943*	
Cornelius	Flavor Fusion 255	629088666*	KBILC** 629088502*	KBILC** 629088505*	KVS 629088681* 629097086*
	IDC215/ID255	629088662*	KBILC** 629088537*	KBILC** 629088536*	KVS 629088677* 629097086*
Lancer	22" Wide	82-4063*	82-4062*		KVS A40403-021 82-3955*
Lancer	30" Wide	82-4061*	82-4060*	82-4059*, KBILC**	KVS A40403-021 82-3633/02*
SerVend	S-150/SV-150	SL27-020000246*	SL30-020000249* CL10-5012116*		KVS SL30-020000249 CL10-5012116*
SerVend	SV-175	SL22-020000198*	SL24-020000200*		KVS SL24-020000200*
SerVend	S-200/SV-200 S-250/SV-250	SL17-5031150*	SL25-5031609*	N3-5031125* CL10-5012116*	KVS SL25-5031609*
Coca-Cola	Freestyle 9000 (free standing)	Contact Coca-Cola for bin adapters	KVS, or KBILC Contact Coca-Cola for bin adapters		KFSTM Contact Coca-Cola for bin adapters
Coca-Cola	Freestyle 7000 (countertop)	Contact Coca-Cola for bin adapters	KVS, or KBILC Contact Coca-Cola for bin adapters	KVS, or KBILC Contact Coca-Cola for bin adapters	11-0353-23 Contact Coca-Cola for bin adapters

* Non Scotsman kits must be purchased from the dispenser manufacturer.

** Recommended but not required.

- Please check with dispenser manufacturer for appropriate kits. Application chart subject to change.
- Blank cells indicate cannot be used together, N/A indicates no adapter needed.
- See spare parts price list for Scotsman A37693-021 & R629088514 pricing.
- Lancer dispensers must be specially configured for dispensing Scotsman Nugget Ice®
- Some Cornelius adapters kits include binstats - do not use the thermostats.
- All Cornelius ED/DF adapter kits have gray doors/covers. Contact Cornelius for black.
- All Cornelius FlavorFusion adapter kits are midnight black. Contact Cornelius for silver, orange or green.
- All Cornelius IDC255 adapter kits are black.

Machine / Bin Sizing Chart

Dimensions in W x D x H - (Height includes 6" legs)

	BINS (Storage)	B322S	B330P	B530P/S	B842S	B948S	BL1048S*	BL1360S*	BL1660S*
ICE MAKERS (Production)	LBS	370	344	536	778	893	1000	1320	1660
MC0322 MC0522	300 500	22" x 34" x 73" 55.9 x 86.4 x 185.4 cm	30" x 34" x 59" 76.2 x 86.4 x 149.9 cm w/KBT27 top	30" x 34" x 73" 76.2 x 86.4 x 185.4 cm w/KBT27 top	42" x 34" x 73" 106.2 x 86.4 x 185.4 cm w/KBT39 top	48" x 34" x 73" 121.9 x 86.4 x 185.4 cm w/KBT38 top or KBT38-2x - side by side			
MC0722	700	22" x 34" x 76" 55.9 x 86.4 x 193.0 cm	30" x 34" x 65" 76.2 x 86.4 x 165.1 cm w/KBT27 top	30" x 34" x 79" 76.2 x 86.4 x 200.7 cm w/KBT27 top	42" x 34" x 79" 106.2 x 86.4 x 200.7 cm w/KBT39 top	48" x 34" x 79" 121.9 x 86.4 x 200.7 cm w/KBT38 top or KBT38-2x - side by side	48" x 31" x 84" 121.9 x 78.7 x 213.3 cm	60" x 31" x 84" 152.4 x 78.7 x 213.3 cm	60" x 31" x 93" 152.4 x 78.7 x 236.2 cm
MC0330 MC0530 MC0630	300 500 600		30" x 34" x 59" 76.2 x 86.4 x 149.9 cm	30" x 34" x 73" 76.2 x 86.4 x 185.4 cm	42" x 34" x 73" 106.7 x 86.4 x 185.4 cm w/KBT29 top	48" x 34" x 73" 121.9 x 86.4 x 185.4 cm w/KBT22B top			
MC0830 MC1030	800 1000			30" x 34" x 79" 76.2 x 86.4 x 200.7 cm	42" x 34" x 79" 106.2 x 86.4 x 200.7 cm w/KBT29 top	48" x 34" x 79" 121.9 x 86.4 x 200.7 cm w/KBT22B top	48" x 31" x 84" 121.9 x 78.7 x 213.3 cm	60" x 31" x 84" 152.4 x 78.7 x 213.3 cm	60" x 31" x 93" 152.4 x 78.7 x 236.2 cm
MC1448 MC1848 MC2148	1400 1800 2000					48" x 34" x 79" 121.9 x 86.4 x 200.7 cm	48" x 31" x 84" 121.9 x 78.7 x 213.3 cm	60" x 31" x 84" 152.4 x 78.7 x 213.3 cm	60" x 31" x 93" 152.4 x 78.7 x 236.2 cm
MC2648	2600					48" x 34" x 84" 121.9 x 86.4 x 213.4 cm	48" x 31" x 89" 121.9 x 78.7 x 226 cm	60" x 31" x 89" 152.4 x 78.7 x 226 cm	60" x 31" x 98" 152.4 x 78.7 x 248.9 cm
MC222L	800 1000						48" x 31" x 84" 121.9 x 78.7 x 213.3 cm	60" x 31" x 84" 152.4 x 78.7 x 213.3 cm	60" x 31" x 93" 152.4 x 78.7 x 236.2 cm
MC330L	1400				42" x 34" x 73" 106.2 x 86.4 x 185.4 cm w/KBT29 top	48" x 34" x 73" 121.9 x 86.4 x 185.4 cm w/KBT22B top	48" x 31" x 78" 121.9 x 78.7 x 198.1 cm	60" x 31" x 78" 152.4 x 78.7 x 198.1 cm	60" x 31" x 87" 152.4 x 78.7 x 221 cm
MC430L	1400 1800				42" x 34" x 79" 106.2 x 86.4 x 200.7 cm w/KBT29 top	48" x 34" x 79" 121.9 x 86.4 x 200.7 cm w/KBT22B top	48" x 31" x 84" 121.9 x 78.7 x 213.3 cm	60" x 31" x 84" 152.4 x 78.7 x 213.3 cm	60" x 31" x 93" 152.4 x 78.7 x 236.2 cm
N0422 N0622	400 600	22" x 34" x 73" 55.9 x 86.4 x 184.4 cm	30" x 34" x 59" 76.2 x 86.4 x 149.9 cm w/KBT27 top	30" x 34" x 73" 76.2 x 86.4 x 185.4 cm w/KBT27 top	42" x 34" x 73" 106.2 x 86.4 x 185.4 cm w/KBT39 top	48" x 34" x 73" 121.9 x 86.4 x 185.4 cm w/KBT38 top or KBT38-2x - side by side			
N0922 N1322	900 1300	22" x 34" x 77" 55.9 x 86.4 x 195.6 cm	30" x 34" x 63" 76.2 x 86.4 x 160.0 cm w/KBT27 top	30" x 34" x 77" 76.2 x 86.4 x 195.6 cm w/KBT27 top	42" x 34" x 77" 106.2 x 86.4 x 195.6 cm w/KBT39 top	48" x 34" x 77" 121.9 x 86.4 x 195.6 cm w/KBT38 top or KBT38-2x - side by side	48" x 31" x 84" 121.9 x 78.7 x 213.3 cm	60" x 31" x 84" 152.4 x 78.7 x 213.3 cm	60" x 31" x 93" 152.4 x 78.7 x 236.2 cm
N2030	2000			30" x 34" x 79" 76.2 x 86.4 x 200.7 cm	42" x 34" x 79" 106.2 x 86.4 x 200.7 cm w/KBT29 top	48" x 34" x 79" 121.9 x 86.4 x 200.7 cm w/KBT22B top	48" x 31" x 84" 121.9 x 78.7 x 213.3 cm	60" x 31" x 84" 152.4 x 78.7 x 213.3 cm	60" x 31" x 93" 152.4 x 78.7 x 236.2 cm
F0522 F0822	500 800	22" x 34" x 73" 55.9 x 86.4 x 184.4 cm	30" x 34" x 59" 76.2 x 86.4 x 149.9 cm w/KBT27 top	30" x 34" x 73" 76.2 x 86.4 x 185.4 cm w/KBT27 top	42" x 34" x 73" 106.2 x 86.4 x 185.4 cm w/KBT39 top	48" x 34" x 73" 121.9 x 86.4 x 185.4 cm w/KBT38 top or KBT38-2x - side by side	48" x 31" x 78" 121.9 x 78.7 x 198.1 cm	60" x 31" x 78" 152.4 x 78.7 x 198.1 cm	60" x 31" x 87" 152.4 x 78.7 x 221 cm
F1222 F1522	1200 1500	22" x 34" x 77" 55.9 x 86.4 x 195.6 cm	30" x 34" x 63" 76.2 x 86.4 x 160.0 cm w/KBT27 top	30" x 34" x 77" 76.2 x 86.4 x 195.6 cm w/KBT27 top	42" x 34" x 77" 106.2 x 86.4 x 195.6 cm w/KBT39 top	48" x 34" x 77" 121.9 x 86.4 x 195.6 cm w/KBT38 top or KBT38-2x - side by side	48" x 31" x 84" 121.9 x 78.7 x 213.3 cm	60" x 31" x 84" 152.4 x 78.7 x 213.3 cm	60" x 31" x 93" 152.4 x 78.7 x 236.2 cm
F2330	2300			30" x 34" x 79" 76.2 x 86.4 x 200.7 cm	42" x 34" x 79" 106.2 x 86.4 x 200.7 cm w/KBT29 top	48" x 34" x 79" 121.9 x 86.4 x 200.7 cm w/KBT22B top	48" x 31" x 84" 121.9 x 78.7 x 213.3 cm	60" x 31" x 84" 152.4 x 78.7 x 213.3 cm	60" x 31" x 93" 152.4 x 78.7 x 236.2 cm
FME2404	2400				42" x 34" x 77" 106.2 x 86.4 x 195.6 cm	48" x 34" x 77" 121.9 x 86.4 x 195.6 cm w/KBT14A top	48" x 31" x 82" 121.9 x 78.7 x 208.3 cm	60" x 31" x 82" 152.4 x 78.8 x 208.3 cm	60" x 31" x 91" 152.4 x 78.7 x 231.1 cm

No bin top required when KBT not listed.

*Universal bin top adapter included for most applications. See above chart for adapters (if applicable).

Ice Only Dispensers

Hotel D-Bins

	IOD150	IOD200	IOD250		HD22	HD30
	150	200	250		120	180
	22" x 31.5" x 58" 55.9 x 77.5 x 145.4 cm w/KBT82 top	30" x 31.5" x 59.75" 76.2 x 77.5 x 149.9 cm w/KBT83 top	30" x 31.5" x 64.5" 76.2 x 77.5 x 160 cm w/KBT83 top		22" x 33.5" x 76.25" 55.9 x 85.1 x 193.7 cm	
	22" x 31.5" x 64" 55.9 x 77.5 x 160.7 cm w/KBT82 top	30" x 31.5" x 65.75" 76.2 x 77.5 x 165.1 cm w/KBT83 top	30" x 31.5" x 70.5" 76.2 x 77.5 x 175.3 cm w/KBT83 top		22" x 33.5" x 82.25" 55.9 x 85.1 x 208.9 cm	
		30" x 31.5" x 58" 76.2 x 77.5 x 145.4 cm w/KBT84 top	30" x 31.5" x 62.75" 76.2 x 77.5 x 155.6 cm w/KBT84 top			30" x 33.5" x 76.25" 76.2 x 85.1 x 193.7 cm
		30" x 31.5" x 64" 76.2 x 77.5 x 160.7 cm w/KBT84 top	30" x 31.5" x 68.75" 76.2 x 77.5 x 170.8 cm w/KBT84 top			
	22" x 31.5" x 65" 55.9 x 77.5 x 163.2 cm w/KBT80 top	30" x 31.5" x 65.25" 76.2 x 77.5 x 163.2 cm w/KBT84 top	30" x 31.5" x 69.75" 76.2 x 77.5 x 173.4 cm w/KBT84 top			
		30" x 31.5" x 58.25" 76.2 x 77.5 x 145.4 cm w/KBT84 top	30" x 31.5" x 63.75" 76.2 x 77.5 x 145.4 cm w/KBT84 top			
		30" x 31.5" x 64" 76.2 x 77.5 x 160.7 cm w/KBT84 top	30" x 31.5" x 68.75" 76.2 x 77.5 x 170.8 cm w/KBT84 top			
	22" x 31.5" x 58" 55.9 x 77.5 x 145.4 cm w/KBT82 top, KNUGAGT	30" x 31.5" x 59.75" 76.2 x 77.5 x 149.9 cm w/KBT83 top KVS, KNUGAGT	30" x 31.5" x 64.5" 76.2 x 77.5 x 160 cm w/KBT83 top KVS, KNUGAGT			
	22" x 31.5" x 62" 55.9 x 77.5 x 155.6 cm w/KBT82 top, KNUGAGT	30" x 31.5" x 63.75" 76.2 x 77.5 x 160 cm w/KBT83 top KVS, KNUGAGT	30" x 31.5" x 68.5" 76.2 x 77.5 x 170.2 cm w/KBT83 top KVS, KNUGAGT			
		30" x 31.5" x 64" 76.2 x 77.5 x 160.7 cm w/KBT84 top KVS, KNUGAGT	30" x 31.5" x 68.75" 76.2 x 77.5 x 170.8 cm w/KBT84 top KVS, KNUGAGT			

Index

3BRTE20-EH	PG. 13	ERC311-32	PG. 11, 21	ICS1360	PG. 28
3BRTE35-EH	PG. 13	ERC311-6	PG. 11, 21	ICS1790	PG. 28
3BRTE50-EH	PG. 13	ERC611-32	PG. 11	ICS730	PG. 28
ADS-AB6	PG. 30	FS0522AX-1	PG. 17	ICS-CP	PG. 28
AP1-P	PG. 30	FS0522WX-1	PG. 17	ICS-DIVIDE	PG. 28
AP2-P	PG. 30	FS0822AX-1	PG. 17	ICS-PADDLE	PG. 28
AP3-P	PG. 30	FS0822R-1	PG. 17	ICS-SHOVEL	PG. 28
APRC1-P	PG. 30	FS0822WX-1	PG. 17	ICS-TOTE	PG. 28
APRC6-P	PG. 30	FS0822WX-32	PG. 17	IOD150	PG. 26
B322S	PG. 27	FS1222AX-32	PG. 17	IOD200	PG. 26
B330P	PG. 27	FS1222L-1	PG. 20	IOD250	PG. 26
B530P	PG. 27	FS1222R-3	PG. 17	IODST22	PG. 27
B530S	PG. 27	FS1222R-32	PG. 17	IODST30	PG. 27
B842S	PG. 27	FS1222WX-32	PG. 17	KBAG	PG. 28
B948S	PG. 27	FS1522AX-32	PG. 17	KBC1	PG. 28
BGS10	PG. 28	FS1522L-1	PG. 20	KBC1P	PG. 28
BL1048S	PG. 27	FS1522R-32	PG. 17	KBILC	PG. 11
BL1360S	PG. 27	FS2330L-32	PG. 20	KBT14A	PG. 29
BL1660S	PG. 27	FS2330R-3	PG. 17	KBT22B	PG. 29
BRTE10	PG. 11, 21	FS2330R-32	PG. 17	KBT27	PG. 29
BRTE25	PG. 11, 21	FS2330W-3	PG. 17	KBT29	PG. 29
BRTE40	PG. 11, 21	FS2330W-32	PG. 17	KBT31	PG. 29
BRTE75	PG. 11, 21	HD22B-1	PG. 26	KBT32	PG. 29
BRTEL25	PG. 11	HD22B-6	PG. 26	KBT38	PG. 29
BRTEL40	PG. 11	HD22W-1	PG. 26	KBT38-2X	PG. 29
BRTEL75	PG. 11	HD30B-1	PG. 26	KBT39	PG. 29
CU0415MAX-1	PG. 15	HD30B-6	PG. 26	KBT45	PG. 29
CU0715MAX-1	PG. 15	HD30W-1	PG. 26	KBT50	PG. 29
CU0920MAX-1	PG. 15	HID207ABX-1	PG. 25	KBT51	PG. 29
CU3030MAX-1	PG. 15	HID207AX-1	PG. 25	KBT52	PG. 29
CU3030MAX-32	PG. 15	HID312AX-1	PG. 25	KBT53	PG. 29
CU3030SAX-1	PG. 15	HID312AWX-1	PG. 25	KBT54	PG. 29
CU3030SAX-32	PG. 15	HID525AX-1	PG. 25	KBT62	PG. 29
CU3030SWX-1	PG. 15	HID525AWX-1	PG. 25	KBT63	PG. 29
CU50GAX-1	PG. 13	HID525WX-1	PG. 25	KBT70	PG. 29
CU50PAX-1	PG. 13	HID540AX-1	PG. 25	KBT71	PG. 29
ECC0800-3	PG. 12, 13	HID540AWX-1	PG. 25	KBT72	PG. 29
ECC0800-6	PG. 12, 13	HID540WX-1	PG. 25	KBT73	PG. 29
ECC1200-32	PG. 12, 13	HST16-A	PG. 25	KBT74	PG. 29
ECC1410-3	PG. 12, 13	HST16B-A	PG. 25	KBT75	PG. 29
ECC1410-32	PG. 12, 13	HST21-A	PG. 25	KBT80	PG. 29
ECC1800-3	PG. 12, 13	HST21B-A	PG. 25	KBT81	PG. 29
ERC111-1	PG. 11, 21	HSTCD16-A	PG. 25	KBT82	PG. 29

Index

KBT83	PG. 29	MC0330SAX-1	PG. 9	MC1448MA-3	PG. 10
KBT84	PG. 29	MC0330SWX-1	PG. 9	MC1448MA-32	PG. 10
KBTABS	PG. 29	MC0522MAX-1	PG. 9	MC1448MR-3	PG. 10
KCMR-230	PG. 21	MC0522MAX-32	PG. 9	MC1448MR-32	PG. 10
KDIL-PN-150	PG. 29	MC0522MWX-1	PG. 9	MC1448MW-3	PG. 10
KDIL-PN-200	PG. 29	MC0522SAX-1	PG. 9	MC1448MW-32	PG. 10
KDIL-PN-250	PG. 29	MC0522SAX-32	PG. 9	MC1448SA-3	PG. 10
KDIL-PN-ID3	PG. 29	MC0522SWX-1	PG. 9	MC1448SA-32	PG. 10
KERCF	PG. 11, 21	MC0522SWX-32	PG. 9	MC1448SR-3	PG. 10
KFS-LTP	PG. 29	MC0530MAX-1	PG. 9	MC1448SR-32	PG. 10
KFSMF	PG. 29	MC0530MAX-32	PG. 9	MC1448SW-3	PG. 10
KFSTM	PG. 29	MC0530MR-1	PG. 9	MC1448SW-32	PG. 10
KHDSANLV	PG. 26	MC0530MWX-1	PG. 9	MC1848MA-32	PG. 10
KHOLDER	PG. 28	MC0530SAX-1	PG. 9	MC1848MR-3	PG. 10
KLP24A	PG. 25	MC0530SAX-32	PG. 9	MC1848MR-32	PG. 10
KLP7	PG. 28	MC0530SR-1	PG. 9	MC1848MW-32	PG. 10
KLP8S	PG. 28	MC0530SWX-1	PG. 9	MC1848SA-32	PG. 10
KNUGAGT	PG. 27	MC0630MAX-1	PG. 9	MC1848SR-3	PG. 10
KNUGDIV	PG. 27	MC0630MAX-32	PG. 9	MC1848SR-32	PG. 10
KPAS	PG. 11, 21	MC0630MR-32	PG. 9	MC1848SW-32	PG. 10
KPFHM-E	PG. 21	MC0630MWX-32	PG. 9	MC2148MR-3	PG. 10
KPUFM30	PG. 15	MC0630SAX-1	PG. 9	MC2148MR-32	PG. 10
KSBU	PG. 11, 21	MC0630SAX-32	PG. 9	MC2148SR-3	PG. 10
KSBU-N	PG. 11, 21	MC0630SR-32	PG. 9	MC2148SR-32	PG. 10
KSEALER	PG. 28	MC0630SWX-32	PG. 9	MC222L	PG. 12
KTAPE	PG. 28	MC0722MAX-1	PG. 9	MC2648MR-3	PG. 10
KTE4	PG. 11, 21	MC0722MAX-32	PG. 9	MC2648SR-3	PG. 10
KTE6-EH	PG. 13	MC0722SAX-1	PG. 9	MC330L	PG. 12
KTEL4	PG. 11	MC0722SAX-32	PG. 9	MC430L	PG. 12
KTPS-SM	PG. 11	MC0830MAX-32	PG. 10	NH0422AX-1	PG. 19
KUFM15	PG. 15, 23	MC0830MR-32	PG. 10	NH0422WX-1	PG. 19
KUFM20	PG. 15, 23	MC0830MWX-32	PG. 10	NH0622AX-1	PG. 19
KUFM24	PG. 15, 23	MC0830SAX-32	PG. 10	NH0622R-1	PG. 19
KVS	PG. 11, 21	MC0830SR-32	PG. 10	NH0622WX-1	PG. 19
MC0322MAX-1	PG. 9	MC0830SWX-32	PG. 10	NH0922AX-1	PG. 19
MC0322MAX-32	PG. 9	MC1030MAX-32	PG. 10	NH0922AX-32	PG. 19
MC0322MWX-1	PG. 9	MC1030MR-3	PG. 10	NH0922L-1	PG. 20
MC0322SAX-1	PG. 9	MC1030MR-32	PG. 10	NH0922R-1	PG. 19
MC0322SWX-1	PG. 9	MC1030MWX-32	PG. 10	NH0922R-32	PG. 19
MC0322SWX-32	PG. 9	MC1030SA-32	PG. 10	NH0922WX-32	PG. 19
MC0330MAX-1	PG. 9	MC1030SR-3	PG. 10	NH1322AX-32	PG. 19
MC0330MAX-32	PG. 9	MC1030SR-32	PG. 10	NH1322L-1	PG. 20
MC0330MWX-1	PG. 9	MC1030SW-32	PG. 10	NH1322R-32	PG. 19

Index

NH1322WX-32	PG. 19	UC2724MWX-1	PG. 15
NH2030R-3	PG. 19	UC2724SAX-1	PG. 15
NH2030R-32	PG. 19	UC2724SWX-1	PG. 15
NH2030W-3	PG. 19	UF0915AX-1	PG. 23
NH2030W-32	PG. 19	UF1415AX-1	PG. 23
NME1854RS-32	PG. 20	UF2020AX-1	PG. 23
NRTE45	PG. 21	UF424AX-1	PG. 23
NS0422AX-1	PG. 19	UF424WX-1	PG. 23
NS0422WX-1	PG. 19	UN0815AX-1	PG. 23
NS0622AX-1	PG. 19	UN1215AX-1	PG. 23
NS0622R-1	PG. 19	UN1520AX-1	PG. 23
NS0622WX-1	PG. 19	UN324AX-1	PG. 23
NS0922AX-1	PG. 19	UN324WX-1	PG. 23
NS0922AX-32	PG. 19	XR-30	PG. 30
NS0922L-1	PG. 20		
NS0922R-1	PG. 19		
NS0922R-32	PG. 19		
NS0922WX-32	PG. 19		
NS1322AX-32	PG. 19		
NS1322L-1	PG. 20		
NS1322R-32	PG. 19		
NS1322WX-32	PG. 19		
NS2030R-3	PG. 19		
NS2030R-32	PG. 19		
NS2030W-3	PG. 19		
NS2030W-32	PG. 19		
PRC241-32	PG. 11		
RCKCME6GX-E	PG. 11		
SC10-A	PG. 31		
SC10RC40	PG. 31		
SC20-A	PG. 31		
SC20RC20	PG. 31		
SSM1-P	PG. 31		
SSM2-P	PG. 31		
SSM3-P	PG. 31		
SSMRC1	PG. 31		
SSMRC6	PG. 31		
UC0918GAX-1	PG. 13		
UC2024MAX-1	PG. 15		
UC2024MWX-1	PG. 15		
UC2024SAX-1	PG. 15		
UC2024SWX-1	PG. 15		
UC2724MAX-1	PG. 15		

Commercial Product Warranty Information



Warranty*

Prodigy Plus®, Eclipse® Cubes, iceValet®

Hotel Dispensers & Bins

(EH, ERC, ECC, HD, BL, B, C0, C1, C2, MC, CB & PR)

3 years parts

3 years labor

5 years parts & labor on Prodigy Evaporator, BL1360,

BL1048, BL1660 & ICS systems

5 years parts on compressor & condenser

15" & 20" Wide Undercounter Ice Machines

(CU0415, CU0715, CU0920, UF0915, UF1415,

UF2020, UN0815, UN1215, UN1520)

3 years parts

3 years labor

Undercounter Gourmet Ice Machines

(CU50)

1 years parts

1 years labor

5 years parts on compressor

(UC0918)

3 years parts

3 years labor

5 years parts on
compressor & condenser

Meridian™ Ice & Water Dispensers

(HID)

3 years parts

3 years labor

5 years parts on compressor & condenser

Prodigy Plus® & AutoSentry™ Flake & Nugget Ice Machines

(FM, NM, FS, NH & NS)

3 years parts

3 years labor

5 years parts on compressor

24" Wide Undercounter Ice Machines

(UC2024, UC2724, UF424, UN324)

3 years parts

3 years labor

5 years parts on compressor

Undercounter Cube Ice Machine

(CU3030)

3 years parts

3 years labor

5 years parts & labor on the evaporator

5 years parts on compressor & condenser

Water Filtration Systems

(SSM & AP)

5 years on manifold parts only

(SSMx-P & SCx0-A)

Ice Only Dispensers

(IOD)

2 years parts

1 years labor

Definitions

- Maximum production capabilities are typical peak production for 24 hours at 70°F/21°C air and 50°F/10°C water
- AHRI certified production capabilities are typical peak production for 24 hours at 90°F/32°C air and 70°F/21°C water
- Maximum capacity is based on 90% of total volume in cubic feet x 34 lb/ft
- (SS) Stainless Steel
- (RC) Rotocast Plastic
- (R-Air) Remote Air
- (RLS) Remote Lowside
- Freight F.O.B. Fairfax, South Carolina



101 Corporate Woods Parkway, Vernon Hills, IL 60061 | 1-800-SCOTSMAN | Fax: 847-913-9844 | www.scotsman-ice.com | orders@scotsman-ice.com

© 2026 Scotsman Ice Systems.

SIS-BR-CPG_0726

