

Scotsman[®]

COMMERCIAL PRODUCT GUIDE

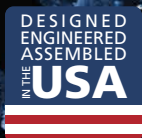
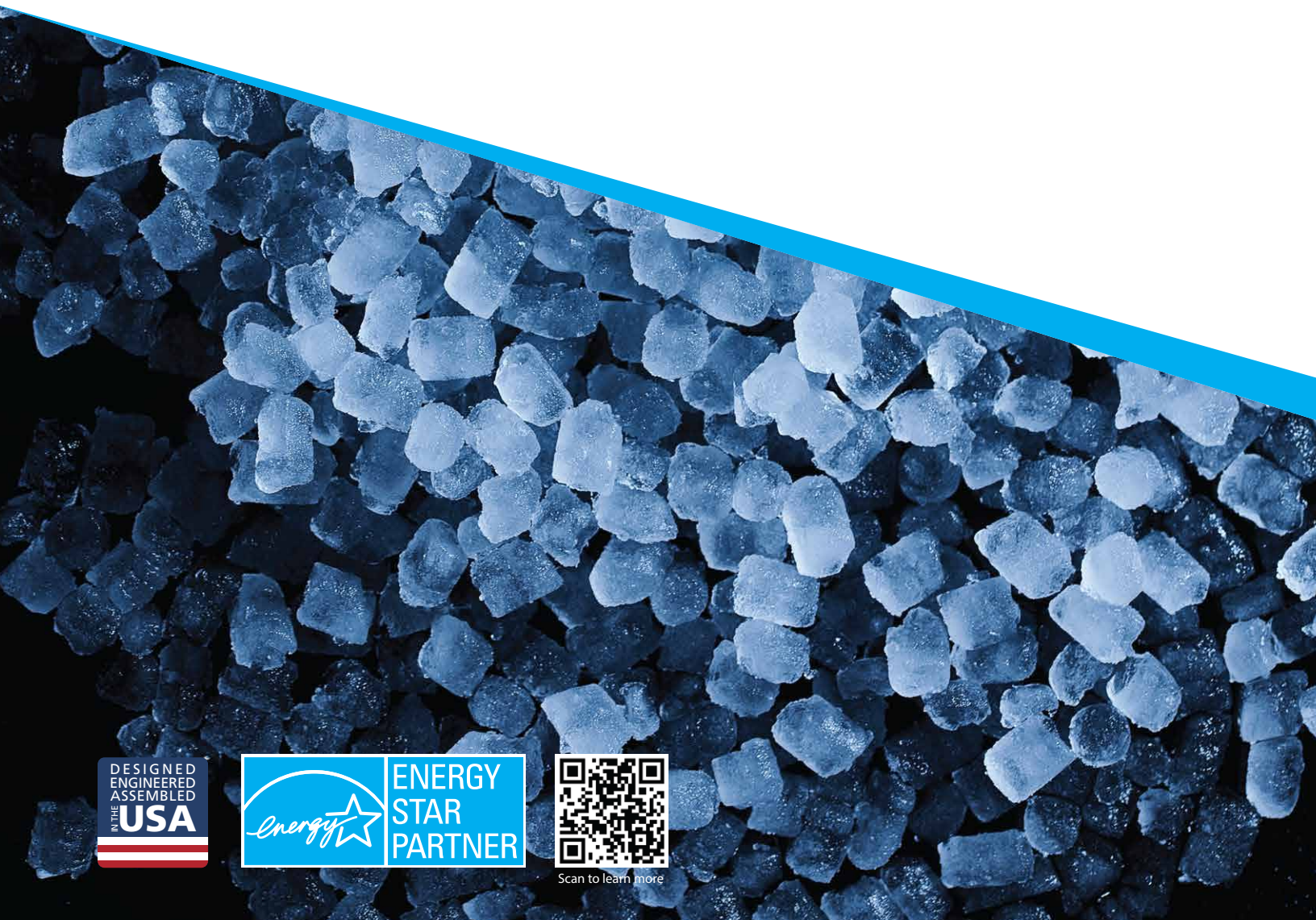

Scan to learn more

TABLE OF CONTENTS

Introduction	3-7
WHY SCOTSMAN	3
RECOGNITION / CERTIFICATION	3
SALES & MARKETING TOOLS	4
MODEL IDENTIFICATION	5
ICE FORMS	6
MACHINE SIZING GUIDELINES	7
Modular Cube Ice Machines	8-13
MODULAR CUBE FEATURES & BENEFITS	8
MODULAR CUBE UNITS	9-10
MODULAR CUBE KITS & ACCESSORIES	11
MODULAR CUBE / REMOTE CONDENSER PACKAGES	12-13
UNDERCOUNTER GOURMET CUBE UNITS	13
Undercounter Cube Ice Machines	14-15
UNDERCOUNTER CUBE FEATURES & BENEFITS	14
UNDERCOUNTER CUBE UNITS & ACCESSORIES	15
Modular Flake Ice Machines	16-17
MODULAR FLAKE FEATURES & BENEFITS	16
MODULAR FLAKE UNITS	17
Modular Nugget Ice Machines	18-21
MODULAR NUGGET FEATURES & BENEFITS	18
MODULAR NUGGET UNITS	19
REMOTE LOW SIDE NUGGET / FLAKE UNITS	20
NUGGET / FLAKE KITS & ACCESSORIES	21
Undercounter Nugget & Flake Ice Machines	22-23
UNDERCOUNTER NUGGET / FLAKE FEATURES & BENEFITS	22
UNDERCOUNTER NUGGET / FLAKE UNITS & ACCESSORIES	23
Ice & Water Dispensers	24-27
ICE & WATER DISPENSER FEATURES & BENEFITS	24
ICE & WATER DISPENSERS	25
DISPENSER STANDS	25
HOTEL / MOTEL DISPENSERS & ACCESSORIES	26
ICE ONLY COUNTER TOP DISPENSERS	26
ICE ONLY DISPENSER KITS & ACCESSORIES	27
Bins & Sanitation	27-35
STORAGE BINS	27
ICE EXPRESS SYSTEM	28
BIN ACCESSORIES	28
BIN TOP KITS / ACCESSORY KITS	29
SANITATION & WATER FILTRATION	30-31
ICE MACHINE TO DISPENSER KIT CHART	33
MACHINE / BIN SIZING CHART	34-35
Index	36-38
Warranty & Definitions	39

WHY SCOTSMAN?



Scotsman - Above and Beyond Great Ice Machines

Scotsman is more than just great ice machines. We back up quality products with The Ultimate Ice Experience. This starts with our world-class manufacturing facility in South Carolina, to our high quality and reliable products, and extends to our dedicated support network. From beginning to end, Scotsman's channel partners and customers get the products, service and support they deserve.



Award Winning Manufacturing & Products

When equipment is functioning smoothly, operators have more time and energy to spend on serving customers. That's why Scotsman offers an impressive array of technology that keeps operators informed – well before issues arise.



Designed, Engineered & Assembled In The USA

At Scotsman, our quality story begins inside our award-winning production facility in South Carolina. And with 99% of our equipment U.S.-based, we're proud to keep things close to home.



24/7 Technical Support

Our Technical Service department has a 24 hour emergency line so there is always a Scotsman representative available to help when you need it. We also have an area on our website specifically dedicated to technical information.



Certified Product Performance

So you don't have to just take our word for it, AHRI provides Scotsman with certifications for almost every single one of our ice machines and bins. Scotsman is ISO 9001:2015 certified with 100% of our units being quality checked before leaving the plant.



Focus on Energy & Savings

Offering several ENERGY STAR® certified models, Scotsman ice machines incorporate a superior design that reduces energy and water consumption, making a difference for the environment and the bottom line. Look for the ✓ symbol throughout the price book to find our qualified products.



Innovative Sales Tools & Trainings

Scotsman has created several tools to help our partners and customers learn more about our brand and products. These tools include the Resource Center, Sales App, Ice Machine Sizing and Selector Tool, Comparison Tool and more.



Sales & Marketing Tools



iPad App

What is it?

An Apple Enterprise iPad App with true on-the-go access to presentations, images and videos, marketing literature and interactive tools

How do I access it?

- Type the below link into your web browser <http://salesapp.scotsman-ice.com/ipad-app/>
- Scan the QR code for instant access
- Visit the Sales App Microsite and click the "Download iPad App" button in the top left corner

Functionality

- Only available for Apple iPads
- Formatted for offline use as a true, on-the-go resource



Scan to access

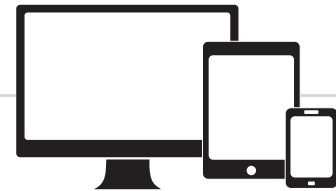

Microsite

What is it?

A web-based microsite with access to presentations, images and videos, marketing literature and interactive tools

How do I access it?

- Type the below link into your web browser <http://salesapp.scotsman-ice.com>
- Scan the QR code for instant access
- Visit the Scotsman website homepage. Click "Resource Center" from the top tool-bar. Then scroll to the Sales Tools section and click "Sales App"

Functionality

- Available on all devices - Computers, tablets & cell phones
- Requires internet connection



Scan to access



Resource Center

What is it?

The Scotsman Resource Center replaces our Library web page and is the ultimate destination for getting Scotsman marketing tools and information.

How do I access it?

- Type the below link into your web browser <http://portal.scotsman-ice.com>
- Scan the QR code for instant access
- From our website home page, click the Resource Center tab

Functionality

- Available on all devices - Computers, tablets & cell phones
- Requires internet connection



Scan to access



Comparison Tool

What is it?

This tool can be used to find the closest machine for a complete comparison of specifications and operating costs.

How do I access it?

- Type the below link into your web browser <https://portal.scotsman-ice.com/ComparisonTool/>
- Scan the QR code for instant access
- From our Resource Center, visit the Sales Tools section, and click on Comparison Tool link

Functionality

- Available on all devices - Computers, tablets & cell phones
- Requires internet connection

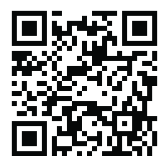

Scan to access



Ice Machine Model Identification

MC0530SA-1A

MC	05	30	S	A	-1	A
model type	capacity 100s of lb	cabinet width (in.)	cube size	condenser type	base electrical volts/hz/phase	series code

- MC** = Cube (Modular)
- CU / UC** = Undercounter Cube
- FS** = Flake (Modular)
- UF** = Undercounter Flake
- NH** = Hard Nugget (Modular)
- NS** = Soft Nugget (Modular)
- UN** = Undercounter Nugget
- HD** = Hotel Dispenser
- HID** = Ice & Water Dispenser
- ID** = Ice Only Dispenser

- S** = Small
- M** = Medium

- A** = Air cooled
- W** = Water cooled
- R** = Remote
- L** = Remote low side

- 1** = 115/60/1
- 32** = 208-230/60/1
- 3** = 208-230/60/3
- 6** = 220-240/50/1

Date Code: Scotsman's production date code is located in the serial number.

2 digit year, 2 digit month, mfg site ID, six numbers

Example: 09061320998877

0906 = Manufactured June, 2009



Price List Tool

What is it?

This tool organizes the most current Scotsman pricing into a searchable, interactive table. Start typing a part number and the filtering will activate.

How do I access it?

- Type the below link into your web browser
<https://portal.scotsman-ice.com/QRCodes/PriceList>
- Scan the QR code for instant access
- From our Resource Center, visit the Price List section, and click on the Price List Tool link

Functionality

- Available on all devices - Computers, tablets & cell phones
- Requires internet connection



Scan to View
Current Pricing



An Ice Form to Meet Every Need



GOURMET ICE

The perfect unique shape for upscale bars and restaurants.

APPLICATIONS: Bar Use
Waitress Stations
Office Suites
Break Rooms

SIZE: 1" x 1 1/8" x 1 1/4"



FLAKE ICE

These small pieces of ice combine fast cooling power with very low production costs.

APPLICATIONS: Blended Cocktails
Salad Bars
Meat & Seafood Displays

SIZE: Compressed Flake Ice



ORIGINAL CHEWABLE NUGGET ICE®

The smallest, softest and most chewable, our proprietary nugget ice is The Original Chewable Ice® - a customer favorite for decades.

APPLICATIONS: Carbonated Beverages
Food Displays
Therapeutic Applications

SIZE: 7/16" x 5/16" x 3/8"



H² NUGGET ICE

Slightly harder, slower melting, nugget ice form that combines more reliable dispensing with the chewable ice that customers love.

APPLICATIONS: Carbonated Beverages
Food Displays
Improved Ice Dispensing
Therapeutic Applications

SIZE: 3/4" x 5/16" x 3/8"



SMALL & MEDIUM CUBE ICE

Our familiar crystal-clear diced ice cube form, available in both small and medium sizes to fit your needs.

APPLICATIONS: Mixed Drinks
Carbonated Beverages
Ice Dispensing
Banquet Services

SIZE: Small: 7/8" x 7/8" x 3/8"
Medium: 7/8" x 7/8" x 7/8"





Guidelines to Sizing Ice Systems

Every operation is different and requires special considerations in sizing equipment. For new locations, use the guidelines below. You may want to add 10-20% for growth or add for unusual types of usage, e.g., icing down drink barrels, bagging ice for resale. For a replacement unit, be sure to ask if the existing unit met the operator's needs. If not, add the amount of ice being purchased to the capacity of the existing unit to determine necessary production for the new unit.

Foodservice

Restaurants:

1.7 lb (0.8 kg) per customer or 5.0 lb (2.3 kg) per seat.

Cocktail Lounge:

3 lb (1.4 kg) per customer.

Salad Bar:

Add 35 lb (15.9 kg) per cubic foot of display. Multiply by 2 or 3 depending on estimated refills required.

Fast Food:

0.9 lb (0.4 kg) per customer or 7.4 lb per seat. Use 2 oz per 8-10 oz drink; 4 oz per 12-16 oz drink.

Convenience Stores/Customer Self-Service

4 oz per 12 oz drink; 7 oz per 20 oz drink; 10 oz per 32 oz drink. Cold plate-add 50% more.

Healthcare:

8 lb (3.6 kg) per patient bed. Use 3 lb (1.4 kg) per employee.

Lodging:

3 lb (1.4 kg) per guest room. Plan on substantially more if guests are allowed to fill ice chests.



Ice Machine Sizing & Selector Tool

What is it?

This tool can be used to find the right machine for your operation. Calculate estimated ice usage and sort ice machine models by categories including: application, ice form, machine width and unit placement.

How do I access it?

- Type the below link into your web browser <https://portal.scotsman-ice.com/SelectorTool/>
- Scan the QR code for instant access
- From our Resource Center, visit the Sales Tools section, and click on Ice Machine Sizing & Selector Tool link

Functionality

- Available on all devices - Computers, tablets & cell phones
- Requires internet connection



Scan to access

PRODIGY ELITE® MODULAR CUBE ICE MACHINES

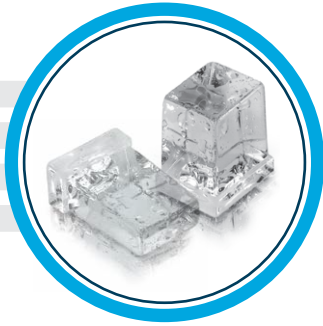

SMALL & MEDIUM CUBE

Small cube: 7/8" x 7/8" x 3/8"
Medium cube: 7/8" x 7/8" x 7/8"



Enhanced AutoAlert indicator lights - Including bin full and Bluetooth pairing with Scotsman's **ICELINQ**® mobile app.



Preservation mode maximizes uptime and notifies users of issues.



Upgraded sensor design enhances cleanability and amplifies durability.



100% Of units are quality checked before leaving our ISO 9001:2015 certified factory in Fairfax, SC.

FEATURING



Bluetooth® Connectivity



Quick & Precise Service Diagnostics



Unit Specific Machine Information



Prodigy ELITE® Modular Cube Utilizing AquaArmor™ with AgION®

*Refer to page 27 & 29 for required bins & bin top kits.



PRODIGY ELITE

MODULAR CUBE

Unit Dimensions (W x D x H)	Cube Size	Model Number	Condenser Type	24 hr Ice Production		Shipping Weight	Volts/Hz/Phase																		
				70°F/21°C 50°F/10°C	Air Water		90°F/32°C 70°F/21°C	115/60/1 -1	208-230/60/1 -32	230/50/1 -6															
 22" x 24" x 23" 55.9 x 61.0 x 58.4 cm	Med. Sm.	MC0322	Air Water Air Water	356/162 366/166 356/162 366/166	Air Water	232/105 292/133 232/105 292/133	155/70 155/70 155/70 155/70	• • • •	• • • •	• ● • ● • ● • ●															
		MC0522									Air Water Air Water	475/216 480/218 475/216 480/218	Air Water	340/154 409/186 340/154 409/186	160/73 160/73 160/73 160/73	• • • •	• • • •	• ● • ● • ● • ●							
		MC0722																	Air Air	758/345 758/345	Air Air	566/257 566/257	189/86 189/86	• •	• ● • ●
		MC0722MA MC0722SA																							

Unit Dimensions (W x D x H)	Cube Size	Model Number	Condenser Type	24 hr Ice Production		Shipping Weight	Volts/Hz/Phase											
				70°F/21°C 50°F/10°C	Air Water		90°F/32°C 70°F/21°C	115/60/1 -1	208-230/60/1 -32	230/50/1 -6								
 30" x 24" x 23" 76.2 x 61.0 x 58.4 cm	Med. Sm.	MC0330	Air Water Air Water	400/182 420/191 400/182 420/191	Air Water	288/131 326/148 288/131 326/148	155/70 155/70 155/70 155/70	• • • •	• • • •	• ● • ● • ● • ●								
		MC0530									Air Remote Water Air Remote Water	525/238 500/227 500/227 525/238 500/227 500/227	Air Remote Water Remote Water	380/172 400/181 410/186 380/172 400/181 410/186	175/80 175/80 175/80 175/80 175/80 175/80	• • • • • •	• • • • • •	• ● • ● • ● • ● • ● • ●
		MC0330MA MC0330MW MC0330SA MC0330SW																
		MC0530MA MC0530MR MC0530MW MC0530SA MC0530SR MC0530SW																

Unit Dimensions (W x D x H)	Cube Size	Model Number	Condenser Type	24 hr Ice Production		Shipping Weight	Volts/Hz/Phase			
				70°F/21°C 50°F/10°C	Air Water		90°F/32°C 70°F/21°C	208-230/60/1 -32	208-230/60/3 N/A	230/50/1 -6
 30" x 24" x 23" 76.2 x 61.0 x 58.4 cm	Med. Sm.	MC0630	Air Remote Water Air Remote Water	640/291 614/279 633/288 640/291 614/279 633/288	Air Remote Water Air Remote Water	474/215 540/245 573/260 474/215 540/245 573/260	190/86 190/86 190/86 190/86 190/86 190/86	• • • • • •	• • • • • •	• ● • ● • ● • ● • ● • ●
		MC0630MA MC0630MR MC0630MW MC0630SA MC0630SR MC0630SW								

✓ = Energy Star certified. ● = CE Approved.

Combine model number and electrical indicator when ordering for exact SKU, i.e. MC0322MA-1. See page 27 for storage bins. Please call for pricing on other international configurations.



Scan to View
Current Pricing

Prodigy ELITE® Modular Cube Utilizing AquaArmor™ with AgION®

Unit Dimensions (W x D x H)	Cube Size	Model Number	Condenser Type	24 hr Ice Production		Shipping Weight lb/kg	Volts/Hz/Phase													
				70°F/21°C 50°F/10°C lb/kg	Air Water		90°F/32°C 70°F/21°C lb/kg	208-230/60/1 -32	208-230/60/3 -3	230/50/1 -6										
 30" x 24" x 29" 76.2 x 61.0 x 73.7 cm	Med.	MC0830		Air Remote Water Air Remote Water	905/411 870/395 924/420 905/411 870/395 924/420	718/326 780/355 832/378 718/326 780/355 832/378	220/100 220/100 220/100 220/100 220/100 220/100	• • • • • •	• • • •	• • • •	● ● ● ●									
		Sm.	MC1030									Air Remote Water Air Remote Water	1077/490 996/453 1029/468 1077/490 996/453 1029/468	816/371 869/395 929/422 816/371 869/395 929/422	235/107 235/107 235/107 235/107 235/107 235/107	• • • • • •	• • • •	• • • •	● ● ● ●	

Unit Dimensions (W x D x H)	Cube Size	Model Number	Condenser Type	24 hr Ice Production		Shipping Weight lb/kg	Volts/Hz/Phase																							
				70°F/21°C 50°F/10°C lb/kg	Air Water		90°F/32°C 70°F/21°C lb/kg	208-230/60/1 -32	208-230/60/3 -3	230/50/1 -6																				
 48" x 24" x 29" 121.9 x 61.0 x 73.7 cm	Med.	MC1448		Air Remote Water Air Remote Water	1553/706 1357/617 1444/656 1553/706 1357/617 1444/656	1296/589 1258/572 1340/609 1296/589 1258/572 1340/609	345/157 345/157 345/157 345/157 345/157 345/157	• • • • • •	✓ • ✓ •	• • • •	• • • •	● ● ● ●																		
		Sm.	MC1848										Air Remote Water Air Remote Water	1909/868 1828/831 1900/864 1909/868 1828/831 1900/864	1426/647 1662/754 1668/757 1426/647 1662/754 1668/757	355/161 355/161 355/161 355/161 355/161 355/161	• • • • • •	• • • •	• • • •	● ● ● ●										
			Med.																		MC2148		Remote Remote	1965/893 1965/893	1746/794 1746/794	370/168 370/168	• •	• •	• •	● ●

Unit Dimensions (W x D x H)	Cube Size	Model Number	Condenser Type	24 hr Ice Production		Shipping Weight lb/kg	Volts/Hz/Phase				
				70°F/21°C 50°F/10°C lb/kg	Air Water		90°F/32°C 70°F/21°C lb/kg	208-230/60/1 N/A	208-230/60/3 -3	230/50/1 N/A	
 48" x 28.5" x 34" 121.9 x 72.39 x 86.36 cm	Med.	MC2648		Remote Remote	2630/1193 2630/1193	2131/967 2131/967	430/195 430/195	• •	• •	• •	● ●

✓ = Energy Star certified. ● = CE Approved.

Combine model number and electrical indicator when ordering for exact SKU, i.e. MC0322MA-1. See page 27 for storage bins. Please call for pricing on other international configurations.

Modular Cube Kits and Accessories

MODULAR CUBE ACCS.

Unit Dimensions (W x D x H)	Model Number	Description	Shipping Weight lb/kg	Volts/Hz/Phase		
				115/60/1 -1	208-230/60/1 -32	230/50/1 -6
29.5" x 29.13" x 38.47" 74.9 x 74.0 x 97.7 cm	ERC111	Remote condenser for MC0530xR	95/43	•		
29.5" x 29.13" x 38.47" 74.9 x 74.0 x 97.7 cm	ERC311	Remote condenser for MC0630xR, MC0830xR, MC1030xR, or MC1448xR	130/59		•	•
29.5" x 37.8" x 38.47" 74.9 x 96.0 x 97.7 cm	ERC611	Remote condenser for MC1848xR or MC2148xR (Works with 50 Hz and 60 Hz units)	140/84		•	
28.5" x 39" x 34.63" 72.4 x 99.1 x 87.9 cm	PRC241	Remote condenser for MC2648xR	135/61		•	

Model Number	Description	Shipping Weight lb/kg
Miscellaneous		
KERCF	Air filter for ERC111 or ERC311	5/2
RCKCME6GX-E	Remote condensing kit for connecting E revision Prodigy® models to non-Scotsman remote condenser coils, Quick connects not included	25/11
KTPS-5M	Tamper Proof Screw Kit (incl. Tool) to convert 22" (55.9 cm), 30" (76.2 cm) or 48" (121.9 cm) cuber	5/2
Line Sets		
BRTE10	Line set, 10 ft, brazing required	7/3
BRTE25	Line set, 25 ft, brazing required	12/6
BRTE40	Line set, 40 ft, brazing required	17/8
BRTE75	Line set, 75 ft, brazing required	35/16
KTE4	Tube end kit - contains 4 quick connect fittings for any RTE Line Set	5/2
BRTEL25	Line set, 25 ft (7.6m), use with C2648 remote cooled units, brazing required	16/7
BRTEL40	Line set, 40 ft (12.2m), use with C2648 remote cooled units, brazing required	22/10
BRTEL75	Line set, 75 ft (22.9m), use with C2648 remote cooled units, brazing required	40/18
KTEL4	Tube end kit - contains 4 quick connect fittings for any RTEL Line Set	5/2
Prodigy ELITE® Modular Cube Accessories		
KPAS	Kit - Prodigy Advanced Sustainability. Includes KSBU-N and KVS	10/4
KSBU	Kit - Prodigy Smart-Board™ - Use additional operational data for fast diagnosis	5/2
KSBU-N	Kit - Prodigy Smart-Board™ - Network connection	5/2
KVS	Kit - Prodigy Vari-Smart™ Ice Level Control - Adjust ice levels to match ice needs	5/2
KBILC	Kit- Basic Ice Level Control - Thermistor technology, ideal for dispenser applications	
XR-30	XSafe® Sanitation System for Modular Cube - Continuous operation, field-installed	

✓ = Energy Star certified. ● = CE Approved.

Combine model number and electrical indicator when ordering for exact SKU, i.e. MC0322MA-1. See page 27 for storage bins. Please call for pricing on other international configurations.



Scan to View
Current Pricing

Prodigy ELITE® Eclipse® Ice Machines



MODULAR REMOTE



Cube Size	Model Number	Use With Condensing Unit	24 hr Ice Production		Shipping Weight lb/kg	Volts/Hz/Phase	
			70°F/21°C 50°F/10°C lb/kg	Air Water		90°F/32°C 70°F/21°C lb/kg	115/60/1 -1
Sm.	Ice Maker MC222SL	ECC0800	850/386		319/145	•	•
		ECC1410	1030/468		332/151	•	•
Sm.	Ice Maker MC330SL	ECC1200	1411/641		310/141	•	
Sm. / Med.	Ice Maker MC430SL / ML	ECC1410	1425/648		332/151	•	
		ECC1800	1775/807		350/159	•	

Features

- Energy efficient components save money on utility costs.
- Better corrosion resistance increases life of unit.
- One piece design makes installation and service easier.
- Maximizes air conditioning load.
- Allows for quiet operation in dining and working environments.
- Able to operate in wide outdoor temperature range from -20° F to 120° F.

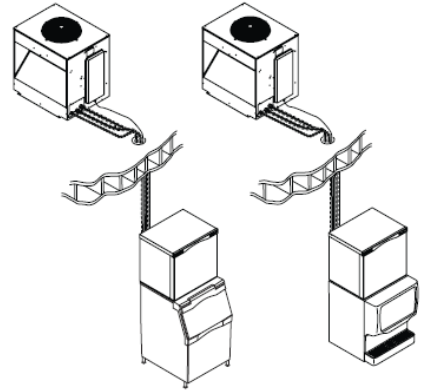

Prodigy Plus® Eclipse® Condensing Unit

Unit Dimensions (W x D x H)	Model Number	Description	Shipping Weight lb/kg	Volts/Hz/Phase		
				208-230/60/1 -32	208-230/60/3 -3	230/50/1 -6
 27" x 32.06" x 39.75" 68.58 x 81.4 x 100.9 cm	Remote Condensers					
	ECC0800	Remote condensing unit Eclipse 800 lb/364 kg systems	319/145		•	
	ECC1200	Remote condensing unit Eclipse 1400 lb/636 kg systems	310/141	•		
	ECC1410	Remote condensing unit Eclipse 1000-1400 lb /455-636 kg systems	332/151	•	•	
	ECC1800	Remote condensing unit Eclipse 1800 lb/818 kg systems	350/159		•	

✓ = Energy Star certified. ● = CE Approved.



Combine model number and electrical indicator when ordering for exact SKU, i.e. MC0322MA-1. See page 27 for storage bins. Please call for pricing on other international configurations.

Model Number	Description	Shipping Weight lb/kg
Line Sets		
3BRTE20-EH	Line set, 20ft. Refrigerant and Brazing required.	21/10
3BRTE35-EH	Line set, 35ft. Refrigerant and Brazing required.	32/15
3BRTE50-EH	Line set, 50ft. Refrigerant and Brazing required.	53/24
3BRTE75-EH	Line set, 75ft. Refrigerant and Brazing required.	79/36
KTE6-EH	Kit, Tube End, 6 Fittings, 3RTExx-EH Line set	5/2

Undercounter Gourmet Cube Units



REMOTE ACCS. & GOURMET

Unit Dimensions (W x D x H)	Model Number	Condenser Type	24 hr Ice Production		Storage Capacity lb/kg	Shipping Weight lb/kg	Volts/Hz/Phase			
			70°F/21°C 50°F/10°C lb/kg	Air Water 90°F/32°C 70°F/21°C lb/kg			115/60/1 -1	208-230/60/1 N/A	230/50/1 N/A	
 14.88" x 22" x 34.38" 37.8 x 55.9 x 87.3 cm	CU50	Air	64/29	44/20	26/12	100/45	•			
	CU50GA CU50PA*									
 18" x 22" x 33" 45.72 x 55.8 x 84 cm Height includes 6" (13.3cm) legs	UC0918	Air	95/43	78/35	33/15	90/41	•			
	UC0918GAX-1									

Standard exterior finish: Stainless Steel.
 *CU50PA-1A comes with a pump drain instead of a gravity drain.



= Energy Star certified. ● = CE Approved.

Combine model number and electrical indicator when ordering for exact SKU, i.e. MC0322MA-1. See page 27 for storage bins. Please call for pricing on other international configurations.



Scan to View
Current Pricing

UNDERCOUNTER CUBE ICE MACHINES

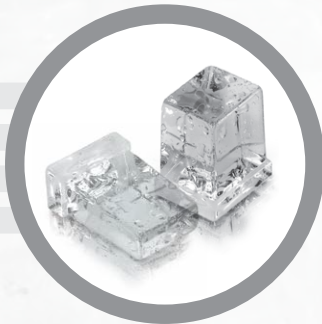

You want ice, not issues. That's why Scotsman created the undercounter line of ice machines. Small in stature. Big on reliability and ease of use. Because at the end of the day, what you really want is a machine that works as hard as you do.

Features & Benefits

Slide back door allows easy access to ice in the bin

Front breathing vents allow for flexible placement

High-volume capacity in a small, compact footprint



Energy Efficient Design:
Environmentally friendly while saving operators money



Unique evaporator produces crystal clear cubes



With an optional floor mount kit, our 15" & 20" wide models can be installed under 34" ADA counter tops



Undercounter Cube Ice Machines



CU0415



15"W x 24"D x 38"H*
38.1 x 61.0 x 96.5 cm

CU0715



15"W x 24"D x 38"H*
38.1 x 61.0 x 96.5 cm

CU0920



20"W x 24"D x 38"H*
50.8 x 61.0 x 96.5 cm

UC2024



24"W x 29"D x 39"H*
61.0 x 73.5 x 99.1 cm

UC2724



24"W x 29"D x 39"H*
61.0 x 73.5 x 99.1 cm

CU3030



30"W x 30"D x 39"H*
76.2 x 76.2 x 99.1 cm

*Height includes 6" (15.2cm) legs

UNDERCOUNTER CUBE

Cube Size	Model Number	Condenser Type	24 hr Ice Production		Storage Capacity	Shipping Weight	Volts/Hz/Phase		
			70°F/21°C 50°F/10°C lb/kg	Air Water			90°F/32°C 70°F/21°C lb/kg	115/60/1 -1	208-230/60/1 -32
Med.	CU0415MA	Air	58/26		36/16	90/41	•		• •
	CU0715MA	Air	80/36		36/16	96/44	•		• •
	CU0920MA	Air	100/45		57/26	118/54	•		• •
Med. Sm.	UC2024MA	Air	227/103		80/36	150/68	• ✓		
	UC2024MW	Water	230/104		80/36	150/68	•		
	UC2024SA	Air	227/103		80/36	150/68	• ✓		
	UC2024SW	Water	230/104		80/36	150/68	•		
Med. Sm.	UC2724MA	Air	282/128		80/36	175/79	•		•
	UC2724MW	Water	266/121		80/36	175/79	•		
	UC2724SA	Air	282/128		80/36	175/79	•		•
	UC2724SW	Water	266/121		80/36	175/79	•		
Med. Sm.	CU3030MA	Air	313/142		110/50	230/104	•	•	• •
	CU3030SA	Air	313/142		110/50	230/104	•	•	• •
	CU3030SW	Water	347/158		110/50	230/104	•		

Undercounter Ice Machine Accessories

Model Number	Description	Shipping Weight lb/kg
KLP85	Kit, Leg 6", Stainless Steel	5/2
KBC1	Kit, Casters	8/4
KUFM15	For ADA applications. Floor mount kit for 15" wide units, lowers overall height to 31.9"	3/1
KUFM20	For ADA applications. Floor mount kit for 20" wide units, lowers overall height to 31.9"	3/1
KUFM24	Floor mount kit for 24" wide units. Lowers height to 33.5"	3/1
KPUFM30	Kit - Prodigy® Undercounter Floor Mount for CU3030	3/1

✓ = Energy Star certified. ● = CE Approved.

Combine model number and electrical indicator when ordering for exact SKU, i.e. MC0322MA-1. Please call for pricing on other international configurations.



Scan to View
Current Pricing

PRODIGY PLUS® MODULAR FLAKE ICE MACHINES

MODULAR FLAKE



Flake ice is perfect for presentation and preservation. It cools more quickly than other ice forms and is ideal for seafood and produce displays. Newly added sealed bearings eliminate the need to grease, while providing better reliability & lower service costs.



Features & Benefits

Small flake ice pieces combine fast cooling power with very low production costs

Smart-Board™ advanced feature module available for additional diagnostic capabilities

Self-aligning front panel for easy access to key components

Optional Vari-Smart™ ice level control allows operators to customize ice levels

Easily visible AutoAlert™ indicator lights & QR code for easy maintenance

NEW



More reliable than ever, sealed, maintenance-free bearings contribute to a longer machine life



Removable front air filter, built-in antimicrobial protection & sealed refrigeration system for easy cleaning & sanitary operation



Stainless steel evaporator & auger for maximum durability



Scotsman®

PRODIGY PLUS

DESIGNED
ENGINEERED
ASSEMBLED
IN THE
USA

Prodigy Plus® Modular Flake Ice Machines

*Refer to page 27 & 29 for required bins & bin top kits.



Unit Dimensions (W x D x H)	Model Number	Condenser Type	24 hr Ice Production			Shipping Weight lb/kg	Volts/Hz/Phase		
			70°F/21°C 50°F/10°C lb/kg	Air Water	90°F/32°C 70°F/21°C lb/kg		115/60/1 -1	208-230/60/1 -32	230/50/1 -6
 22" x 24" x 23" 55.9 x 61.0 x 58.4 cm	F0522	Air Water	450/205 530/240	372/169 409/186	173/78 173/78	• •			
	FS0522A FS0522W								
	F0822	Air Remote Water	800/363 760/345 775/352	606/275 589/268 581/264	175/79 175/79 175/79	• • •	•		
	FS0822A								
	FS0822R FS0822W								

Unit Dimensions (W x D x H)	Model Number	Condenser Type	24 hr Ice Production			Shipping Weight lb/kg	Volts/Hz/Phase		
			70°F/21°C 50°F/10°C lb/kg	Air Water	90°F/32°C 70°F/21°C lb/kg		208-230/60/1 -32	208-230/60/3 -3	230/50/1 -6
 22" x 24" x 27" 55.9 x 61.0 x 68.6 cm	F1222	Air Remote Water	1100/500 1250/567 1240/562	861/391 875/398 933/424	220/100 220/100 220/100	• ✓ • •	• ✓ • •		
	FS1222A FS1222R FS1222W								
	F1522	Air Remote	1612/733 1507/684	1100/500 1133/515	224/102 224/102	• •	•		
	FS1522A FS1522R								

Unit Dimensions (W x D x H)	Model Number	Condenser Type	24 hr Ice Production			Shipping Weight lb/kg	Volts/Hz/Phase		
			70°F/21°C 50°F/10°C lb/kg	Air Water	90°F/32°C 70°F/21°C lb/kg		208-230/60/1 -32	208-230/60/3 -3	230/50/1 -6
 30" x 24" x 29" 76.2 x 61.0 x 73.7 cm	F2330	Remote Water	2218/1006 2405/1091	1861/844 2042/926	335/152 335/152	• •	• •		
	FS2330R FS2330W								

Unit Dimensions (W x D x H)	Model Number	Condenser Type	24 hr Ice Production			Shipping Weight lb/kg	Volts/Hz/Phase	
			70°F/21°C 50°F/10°C lb/kg	Air Water	90°F/32°C 70°F/21°C lb/kg		208-230/60/1 -32	230/50/1 N/A
 42" x 24" x 27" 106.7 x 61.0 x 68.6 cm	FME2404AS	Air	2455/1114	1792/813	395/179	•		

MODULAR FLAKE

✓ = Energy Star certified. ● = CE Approved.

Combine model number and electrical indicator when ordering for exact SKU, i.e. MC0322MA-1. See page 27 for storage bins. Please call for pricing on other international configurations.



Scan to View
Current Pricing

PRODIGY PLUS® MODULAR NUGGET ICE MACHINES



Soft, cylindrical and slow-melting, our proprietary nugget ice is The Original Chewable Ice® - a customer favorite for decades. Also available in H² Nugget ice that provides more reliable dispensing.

MODULAR NUGGET



Features & Benefits

NEW

Now available in softer Original Chewable Nugget Ice or harder, H² Nugget Ice

Smart-Board™ advanced feature module available for additional diagnostic capabilities

Self-aligning front panel for easy access to key components

Optional Vari-Smart™ ice level control allows operators to customize ice levels



Easily visible AutoAlert™ indicator lights & QR code for easy maintenance

NEW



More reliable than ever, sealed, maintenance-free bearings contribute to a longer machine life



Removable front air filter, built-in antimicrobial protection & sealed refrigeration system for easy cleaning & sanitary operation

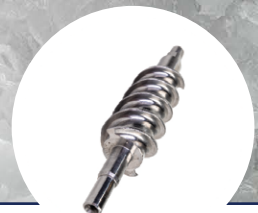

Stainless steel evaporator & auger for maximum durability

Scotsman®

PRODIGY PLUS

DESIGNED
ENGINEERED
ASSEMBLED
IN THE
USA

Prodigy Plus® Modular Nugget Ice Machines

*Refer to page 27 & 29 for required bins & bin top kits.



Unit Dimensions (W x D x H)	Nugget Type	Model Number	Condenser Type	24 hr Ice Production		Shipping Weight lb/kg	Volts/Hz/Phase			
				70°F/21°C 50°F/10°C lb/kg	Air Water		90°F/32°C 70°F/21°C lb/kg	115/60/1 -1	208-230/60/1 -32	230/50/1 -6
 <p>22" x 24" x 23" 55.9 x 61.0 x 58.4 cm</p>	Hard	N0422		Air	456/207	327/149	172/78	•		
		Water	NH0422A	441/200	370/168	172/78	•			
			NH0422W	420/191	320/145	172/78	•			
		Air	NS0422A		455/206	386/175	172/78	•		
	NS0422W									
	Soft	N0622		Air	644/292	466/212	180/82	•	•	
		Remote	NH0622A	631/286	494/225	180/82	•			
			NH0622R	640/290	505/230	180/82	•			
		Water	NS0622A		643/292	530/241	180/82	•	•	•
			NS0622R		660/299	515/234	180/82	•		
NS0622W		715/324	515/234	180/82	•					

Unit Dimensions (W x D x H)	Nugget Type	Model Number	Condenser Type	24 hr Ice Production		Shipping Weight lb/kg	Volts/Hz/Phase				
				70°F/21°C 50°F/10°C lb/kg	Air Water		90°F/32°C 70°F/21°C lb/kg	115/60/1 -1	208-230/60/3 -3	208-230/60/1 -32	230/50/1 -6
 <p>22" x 24" x 27" 55.9 x 61.0 x 68.6 cm</p>	Hard	N0922		Air	952/432	676/307	210/95	•	✓	•	✓
		Remote	NH0922A	896/406	717/326	210/95	•		•	✓	
			NH0922R	908/412	740/336	210/95	•		•	✓	
		Water	NS0922A		956/434	740/336	210/95	•	✓	•	•
	NS0922R		1044/474	754/343	210/95	•		•			
	Air	NS0922W		1094/496	817/371	210/95	•		•		
	Soft	N1322		Air	1186/537	866/394	225/102			•	
		Remote	NH1322A	1191/540	1000/455	225/102			•		
			NH1322R	1242/563	1033/470	225/102	•		•		
		Water	NS1322A		1385/628	954/434	225/102			•	
			NS1322R		1360/617	1077/490	225/102			•	
		NS1322W		1513/686	1115/507	225/102	•		•		

Unit Dimensions (W x D x H)	Nugget Type	Model Number	Condenser Type	24 hr Ice Production		Shipping Weight lb/kg	Volts/Hz/Phase		
				70°F/21°C 50°F/10°C lb/kg	Air Water		90°F/32°C 70°F/21°C lb/kg	208-230/60/1 -32	208-230/60/3 -3
 <p>30" x 24" x 29" 76.2 x 61.0 x 73.7 cm</p>	Hard	N2030		Remote	1806/819	1555/705	337/153	•	•
		Water		NH2030R	2003/909	1723/782	337/153	•	•
	Soft	NS2030R		1886/855	1618/734	337/153	•	•	
		NS2030W		2121/962	1781/808	337/153	•	•	

✓ = Energy Star certified. ● = CE Approved.

Combine model number and electrical indicator when ordering for exact SKU, i.e. MC0322MA-1. See page 27 for storage bins. Please call for pricing on other international configurations.





Scan to View
Current Pricing

MODULAR NUGGET



MODULAR REMOTE LOW SIDE

Unit Dimensions (W x D x H)	Model Number	Ice Form	24 hr Ice Production		Shipping Weight lb/kg	Volts/Hz/Phase	
			70°F/21°C 50°F/10°C lb/kg	Air Water		90°F/32°C 70°F/21°C lb/kg	115/60/1 -1
 22" x 24" x 27" 55.9 x 61.0 x 68.6 cm	FS1222L FS1522L	Flake	1180/535		1000/454	217/98	•
		Flake	1445/655		1205/547	224/102	•

Unit Dimensions (W x D x H)	Model Number	Ice Form	24 hr Ice Production		Shipping Weight lb/kg	Volts/Hz/Phase	
			70°F/21°C 50°F/10°C lb/kg	Air Water		90°F/32°C 70°F/21°C lb/kg	115/60/1 -1
 30" x 24" x 29" 76.2 x 61.0 x 73.7 cm	FS2330L	Flake	2275/1032		1900/862	233/106	•

Unit Dimensions (W x D x H)	Nugget Type	Model Number	Ice Form	24 hr Ice Production		Shipping Weight lb/kg	Volts/Hz/Phase	
				70°F/21°C 50°F/10°C lb/kg	Air Water		90°F/32°C 70°F/21°C lb/kg	115/60/1 -1
 22" x 24" x 27" 55.9 x 61.0 x 68.6 cm	Hard Soft	NH0922L	Nugget	889/403		766/347	217/98	•
		NH1322L	Nugget	1191/540		1018/462	225/102	•
		NS0922L	Nugget	1090/494		915/415	217/98	•
		NS1322L	Nugget	1330/603		1100/499	225/102	•

FLAKE NUGGET



➤ Flake ice is a smart choice for everything from blended cocktails and salad bars to produce, seafood and meat displays. It is also a popular choice for therapeutic use in healthcare facilities.

➤ Our original Nugget ice is the best choice for carbonated beverages and therapeutic use. The H² Nugget allows for better dispensing and also melts slower.

✓ = Energy Star certified. ● = CE Approved.

Combine model number and electrical indicator when ordering for exact SKU, i.e. MC0322MA-1. See page 27 for storage bins. Please call for pricing on other international configurations.

Nugget & Flake Ice Machine Kits and Accessories

Unit Dimensions (W x D x H)	Model Number	Description	Shipping Weight lb/kg	Volts/Hz/Phase		
				115/60/1 -1	208-230/60/1 -32	230/50/1 -6
29.5" x 29.13" x 38.47" 74.9 x 74.0 x 97.7 cm	Remote Condensers ERC111	Remote condenser for F0822R, N0622R or N0922R-1	95/43	•		
29.5" x 29.13" x 38.47" 74.9 x 74.0 x 97.7 cm	ERC311	Remote condenser for F1222R, F1522R, N0922R-32 or N1322R	130/59		•	•
29.5" x 37.8" x 38.47" 74.9 x 96.0 x 97.7 cm	ERC611	Remote condenser for F2330R and N2030R	140/84		•	

Model Number	Description	Shipping Weight lb/kg
Line Sets		
BRTE10	Line set, 10 ft, brazing required	7/3
BRTE25	Line set, 25 ft, brazing required	12/5
BRTE40	Line set, 40 ft, brazing required	17/7
BRTE75	Line set, 75 ft, brazing required	35/15
KTE4	Tube end kit - Contains 4 quick connect fittings for any RTE Line Set	5/2
Miscellaneous		
KERCF	Air filter for ERC111 or ERC311	5/2
KPFHM-E	Headmaster Kit for use with ERC101, ERC151, ERC201, ERC302 or PR2C240; Quick connect not included	10/5
KCMR-230	Fan relay kit for two 230V units connected to PR2C240 condenser	5/2
Prodigy Modular Flake & Nugget Accs.		
KPAS	Kit-Prodigy Advanced Sustainability. Includes KSBU-N and KVS	10/4
KSBU	Kit-Prodigy Smart-Board™ - Use additional operational data for fast diagnosis	5/2
KSBU-N	Kit-Prodigy Smart-Board™ - Network connection	5/2
KVS	Kit-Prodigy Vari-Smart™ Ice Level Control - Adjust ice levels to match ice needs	5/2

MODULAR NUGGET & FLAKE ACCS.

✓ = Energy Star certified. ● = CE Approved.

Combine model number and electrical indicator when ordering for exact SKU, i.e. MC0322MA-1. See page 27 for storage bins. Please call for pricing on other international configurations.



Scan to View Current Pricing

UNDERCOUNTER NUGGET & FLAKE ICE MACHINES



Get the nugget and flake ice your customers love anywhere you need it with Scotsman's undercounter ice machines. With a proven freezer design and sealed bearings, you'll have the reliable machine your facility requires – with a more compact design.

BIG
OPPORTUNITY
SMALL UNIT

Features & Benefits

Slide back door allows easy access to ice in the bin

Front breathing vents allow for flexible placement

High-volume capacity in a small, compact footprint



Energy Star Certified*: Environmentally friendly while saving operators money



Sealed, maintenance-free bearings ensure **maximum reliability** & contribute to a long machine lifetime



With an optional floor mount kit, our 15" & 20" wide models can be installed under **34" ADA counter tops**

*Select models only.

Scotsman®



UNDERCOUNTER NUGGET & FLAKE

Undercounter Nugget and Flake Ice Machines



UN0815



15"W x 24"D x 38"H*
38.1 x 61.0 x 96.5 cm

UN1215



15"W x 24"D x 38"H*
38.1 x 61.0 x 96.5 cm

UN1520



20"W x 24"D x 38"H*
50.8 x 61.0 x 96.5 cm

UN324



24"W x 28.5"D x 39"H*
61.0 x 72.4 x 99.1 cm

UF0915



15"W x 24"D x 38"H*
38.1 x 61.0 x 96.5 cm

UF1415



15"W x 24"D x 38"H*
38.1 x 61.0 x 96.5 cm

UF2020



20"W x 24"D x 38"H*
50.8 x 61.0 x 96.5 cm

UF424



24"W x 28.5"D x 39"H*
61.0 x 72.4 x 99.1 cm

*Height includes 6" (15.2cm) legs

Model Number	Condenser Type	24 hr Ice Production		Storage Capacity lb/kg	Shipping Weight lb/kg	Volts/Hz/Phase	
		70°F/21°C 50°F/10°C lb/kg	Air Water 70°F/21°C 70°F/21°C lb/kg			115/60/1 -1	230/50/1 -6
Nugget Units							
UN0815A	Air	79/36	55/25	36/16	108/49	• ✓✓✓	•
UN1215A	Air	119/54	84/38	36/16	109/49	• ✓✓✓	
UN1520A	Air	167/76	125/57	57/26	129/59	• ✓✓✓	
UN324A	Air	340/154	266/121	80/36	210/95	• ✓✓✓	•
UN324W	Water	340/154	281/127	80/36	210/95	• ✓✓✓	
Flake Units							
UF0915	Air	96/44	76/35	36/16	108/49	• ✓✓✓	
UF1415	Air	142/64	107/49	36/16	109/49	• ✓✓✓	
UF2020	Air	216/98	149/68	57/26	129/59	• ✓✓✓	
UF424A	Air	440/200	310/141	80/36	200/91	• ✓✓✓	•
UF424W	Water	440/200	330/150	80/36	200/91	• ✓✓✓	

UNDERCOUNTER NUGGET & FLAKE

Undercounter Ice Machine Accessories

Model Number	Description	Shipping Weight lb/kg
KLP85	Kit, Leg 6", Stainless Steel	5/2
KBC1	Kit, Casters	8/4
KUFM15	For ADA applications. Floor mount kit lowers overall height to 31.9"	3/1
KUFM20	For ADA applications. Floor mount kit lowers overall height to 31.9"	3/1
KUFM24	Floor mount kit. Lowers height to 33.5"	3/1

✓ = Energy Star certified. ● = CE Approved.

Combine model number and electrical indicator when ordering for exact SKU, i.e. MC0322MA-1. Please call for pricing on other international configurations.



Scan to View Current Pricing

meridian

ICE AND WATER DISPENSERS



Sealed, Maintenance-Free Bearings
Reduces preventative maintenance and extends unit longevity.



Easily Removable Air Filter
Side mounted and easy to remove, clean, and re-install for simple upkeep on all Meridian™ models.



Category Best Warranty
3 years parts and labor. 5 years parts on compressor and condenser.



Sanitary Design
AglION™ antimicrobial technology is molded into key components to help inhibit the growth of microbes, bacteria, mold, and algae. Sealed refrigeration system minimizes outside airborne contamination.



ICE & WATER DISPENSERS



HID207

Compact Ice and Water Dispenser

FEATURES



Maximum Uptime
Integrated drain cover and consolidated drain ensures reliable operation.



UV-LED Sanitation
Internal UV module actively treats incoming water to ensure clean, refreshing ice and water.



ADA Compliant Dispensing Area
Touch-free and push-button models meet ADA reach range requirements.



AutoAlert™ Indicator Panel
Intuitively displays relevant machine status that is visible across the room.



Easily Removable Components
Fully removable air filter, spouts, sink, grill, and bin allow for easy cleaning and maintenance.



Original, Chewable Nugget Ice®
Preferred by customers and originally produced by Scotsman in 1981.

Scotsman®



Ice and Water Dispensers



HID207



HID207A & HID207AB
16.25" x 24.38" x 17.54"

HID312



HID312A & HID312AB:
16.25" x 24.38" x 35"
HID312AW: 18.25" x 24.38" x 35"

HID525



HID525A & HID525AB:
21.25" x 24.38" x 35"
HID525AW: 23.25" x 24.38" x 35"
HID525W & HID525WB:
21.25" x 24.38" x 35"

HID540



HID540A & HID540AB:
21.25" x 24.38" x 41"
HID540AW: 23.25" x 24.38" x 41"
HID525W & HID540WB:
21.25" x 24.38" x 41"

Model Number	Condenser Type	Dispensing Method	24 hr Ice Production		Storage Capacity lb/kg	Shipping Weight lb/kg	Volts/Hz/Phase	
			70°F/21°C 50°F/10°C lb/kg	Air Water lb/kg			90°F/32°C 70°F/21°C lb/kg	115/60/1 -1
HID207								
HID207AX	Air	Touch-Free Sensor	196/89		7/3.17	80/36.29	•	✓
HID207ABX	Air	Button Activated	196/89		7/3.17	80/36.29	•	✓
HID312								
HID312A	Air	Touch-Free Sensor	260/118		12/5	183/83	•	•
HID312AB	Air	Button Activated	260/118		12/5	183/83	•	•
HID312AW*	Air	Touch-Free Sensor	260/118		12/5	188/85	•	•
HID525								
HID525A	Air	Touch-Free Sensor	500/227		25/11	208/94	•	•
HID525AB	Air	Button Activated	500/227		25/11	208/94	•	•
HID525AW*	Air	Touch-Free Sensor	500/227		25/11	213/97	•	•
HID525W	Water	Touch-Free Sensor	500/227		25/11	208/94	•	•
HID525WB	Water	Button Activated	500/227		25/11	208/94	•	•
HID540								
HID540A	Air	Touch-Free Sensor	500/227		40/18	215/98	•	•
HID540AB	Air	Button Activated	500/227		40/18	215/98	•	•
HID540AW*	Air	Touch-Free Sensor	500/227		40/18	220/100	•	•
HID540W	Water	Touch-Free Sensor	500/227		40/18	215/98	•	•
HID540WB	Water	Button Activated	500/227		40/18	215/98	•	•
KLP24A	4" adjustable legs, plastic with metal foot (box of 4)					5/2		

*Wall mount configuration. Does not have drip tray. Designed to be installed over existing sink.

ICE & WATER DISPENSERS

Ice and Water Dispenser Stands

HSTCD16-A



HSTCD16-A: 16.5" x 23.56" x 32"
41.9 x 59.8 x 81.3 cm
Height includes 6" (15.2cm) legs

HST16-A



HST16-A: 16.5" x 23.75" x 32"
41.9 x 60.3 x 81.3 cm
Height includes 6" (15.2cm) legs

HST16B-A



HST16B-A: 16.5" x 23.75" x 32"
41.9 x 60.3 x 81.3 cm
Height includes 6" (15.2cm) legs

HST21-A



HST21-A: 21.5" x 23.75" x 32"
54.6 x 60.3 x 81.3 cm
Height includes 6" (15.2cm) legs

HST21B-A



HST21B-A: 21.5" x 23.75" x 32"
54.6 x 60.3 x 81.3 cm
Height includes 6" (15.2cm) legs

Model Number	Description	Shipping Weight lb/kg
HSTCD16-A	Stand with door, use with HID207, includes 6" legs	55/25
HST16-A	Stand with door, use with HID312, SS, includes 6" legs	50/23
HST16B-A	Stand for HID312, basic version, SS, includes 6" legs	50/23
HST21-A	Stand with door, use with HID525 & HID540, SS, includes 6" legs	80/36
HST21B-A	Stand for HID525 & HID540, basic version, SS, includes 6" legs	80/36

✓ = Energy Star certified. ● = CE Approved.

Combine model number and electrical indicator when ordering for exact SKU, i.e. MC0322MA-1. Please call for pricing on other international configurations.



Scan to View Current Pricing

Hotel / Motel Cube Dispensers

HD22



22" x 33.5" x 53.25"
55.9 x 85.1 x 135.3 cm
Height includes 6" (15.2cm) legs

HD30



30" x 33.5" x 53.25"
76.2 x 85.1 x 135.3 cm
Height includes 6" (15.2cm) legs

Model Number	Dispensing Method	Storage Capacity lb/kg	Shipping Weight lb/kg	Volts/Hz/Phase	
				115/60/1 -1	230/50/1 -6
HD22	Lever Activated	120/59	201/91	•	• ●
HD22B					
HD30	Lever Activated Water Filler	180/81 180/81	220/100 225/102	• •	• ●
HD30B HD30W					
Model Number	Description	Unit Dimensions		Shipping Weight	
KHDSANLV	Sanitary lever kit for HD models	12" x 6" x 6" 30.5 x 15.2 x 15.2 cm (W x D x H)		5/2 lb/kg	

HD & ID DISPENSERS

Ice Only Counter Top Dispensers

IOD150



23" x 31" x 35"
58.42 x 78.74 x 88.9 cm

IOD200



30" x 31" x 35"
76.2 x 78.74 x 88.9 cm

IOD250



30" x 31" x 41"
76.2 x 78.74 x 104.14 cm

Model Number	Dispensing Method	Storage Capacity lb/kg	Shipping Weight lb/kg	Volts/Hz/Phase	
				115/60/1 -1	
Ice Only Dispensers					
IOD150	Lever Activated	150/68	185/84	•	
IOD150WF*	Lever Activated	150/68	185/84	•	
IOD200	Lever Activated	200/91	235/106	•	
IOD200WF*	Lever Activated	200/91	235/106	•	
IOD250	Lever Activated	250/114	260/118	•	
IOD250WF*	Lever Activated	250/114	260/118	•	

*WF models include a factory installed water fill lever.



✓ = Energy Star certified. ● = CE Approved.

Combine model number and electrical indicator when ordering for exact SKU, i.e. MC0322MA-1. Please call for pricing on other international configurations.

Ice Only Dispenser Kits and Accessories

Unit Dimensions (W x D x H)	Model Number	Description	Shipping Weight lb/kg
 <p>IODST22: 22" x 29" x 30" 55.9 x 73.7 x 76.2 cm Height includes 6" (15.2cm) legs</p> <p>IODST30: 30" x 29" x 30" 76.2 x 73.7 x 76.2 cm Height includes 6" (15.2cm) legs</p>	Machine Stands	Machine stand for IOD150 Machine stand for IOD200 & IOD250	105/47 110/49
	IODST22 IODST30		
	Kits	Field installed agitator kit for IOD150, IOD200, & IOD250 when used for nugget ice applications	10/5
	KNUGAGT		

Storage Bins

Model Number	Storage Capacity lb/kg	Ext. Finish	Liner Material	Unit Dimensions (W x D x H)	Shipping Weight lb/kg	
	Modular Bins					
	B322S	370/168	Metallic	Poly	22" x 34" x 50" (55.9 x 86.4 x 127 cm)	140/64
	B330P	344/156	Poly	Poly	30" x 34" x 37" (76.2 x 86.4 x 94 cm)	90/41
	B530P	536/244	Poly	Poly	30" x 34" x 50" (76.2 x 86.4 x 127 cm)	110/50
	B530S	536/244	Metallic	Poly	30" x 34" x 50" (76.2 x 86.4 x 127 cm)	150/68
	B842S	778/353	Metallic	Poly	42" x 34" x 50" (106.7 x 86.4 x 127 cm)	190/86
	B948S	893/406	Metallic	Poly	48" x 34" x 50" (121.9 x 86.4 x 127 cm) Height includes 6" (15.2cm) legs	209/95
	BL Upright Modular Bins					
	BL1048S	1000/454	SS	Poly	48" x 31" x 54.4" (121.9 x 78.7 x 138.2 cm)	268/122
	BL1360S	1320/599	SS	Poly	60" x 31" x 54.4" (152.4 x 78.7 x 138.2 cm)	322/147
	BL1660S	1660/753	SS	Poly	60" x 31" x 63.4" (152.4 x 78.7 x 161 cm) Height includes 6" (15.2cm) legs	340/154



BL bins include universal adapter plate for use with most ice machines. See machine bin sizing chart on pages 34-35 for special configurations.



Ice Express System Built-to-Order Only

Unit Dimensions (W x D x H)	Model Number	Description	Storage Capacity lb/kg	Ext. Finish	Liner Material	Shipping Weight lb/kg
 <p>ICS730 31" x 40" x 75" 78.7 x 101.6 x 1968.5 cm</p> <p>ICS1360 60" x 40" x 75" 152.4 x 101.6 x 190.5 cm</p> <p>ICS1790 90" x 40" x 70" 228.6 x 101.6 x 177.8 cm</p>	Ice Express System					
	ICS730	1 Bay*	652/296	SS	Poly	398/181
	ICS1360	2 Bay*	1327/603	SS	Poly	712/323
	ICS1790	3 Bay*	1716/779	SS	Poly	978/444
	Options					
ICS-PADDLE	Replacement paddle, white plastic	N/A	Poly	N/A	9/4	
ICS-SHOVEL	Shovel, white plastic	N/A	Poly	N/A	9/4	
ICS-CP	Replacement Poly Cart	240/109	Poly	N/A	75/34	
ICS-TOTE	Ice Totes - Set of 6	150/68	Poly	N/A	34/15	
* Includes 1 poly cart for each bay.						

Bin Accessories

Unit Dimensions (W x D x H)	Model Number	Description	Shipping Weight lb/kg
	Caster Kits		
	KBC1	Bin caster kit for B530S, B842S, B948S, SB480, UC2024, UC2724, CU3030, BH bins, UF & UN Undercounter models [3.5" (8.9 cm) diameter wheels, 2 standard wheels and 2 locking. Raises bin 4 7/16" (11.3 cm)] - Not to be used with SB480 when using extension or B222S or B322S.	8/4
	KBC1P	Bin caster kit for B330P and B530P. [3.5" (8.9 cm) diameter wheels, 2 standard wheels and 2 locking. Raises bin a maximum of 4 7/16" (11.3 cm).	20/9
	Leg Kits		
	KLP7	Kit, legs, 6" black enamel, flanged feet, B Bins, HST stands, HD dispensers, CU0515, UC2024, UC2724, CU3030, UF & UN Undercounter models.	5/2
	KLP8S	Kit, legs, 6" stainless steel, Bx22, Bx30, B842, B948, HST stands, HD dispensers CU1526, CU2026, CU3030, UF & UN Undercounter models. Note: Legs are supplied with self-contained machines, bins and machine stands.	5/2
 <p>19 1/4" x 10 3/4" x 28 1/2" 48.9 x 27.3 x 72.4 cm</p>	Ice Bagger		
	BGS10 KBAG KTAPE KSEALER	Hooks over any ice bin opening. Aluminum. Case of 1000 8lb bags. One roll - 180 ft (54.9 m) Tape sealer. Note: BGS10 includes easy bagger, wicket of bags (250), tape sealer and 1 roll of tape.	25/11 30/14 1/0.5 5/2
	Ice Scoop Holder		
	KHOLDER	Stainless steel scoop holder. Fits all B330, B530, B842 and B948 ice storage bins	2/1



Scan to View
Current Pricing

Bin Top Kits

Model Number	Description	Shipping Dimensions L x W x H	Use On	Shipping Weight lb/kg
KBT14A	NME1854, FME2404	10" x 27" x 5"	B948	8/4
KBT22B	All 30" (76.2 cm) modular cube, flake or nugget ice makers	17" x 29" x 5"	B948	11/5
KBT27	All 22" (55.9 cm) modular cube, flake or nugget ice makers except MC222L	10" x 27" x 5"	B330, B530	8/4
KBT29	All 30" (76.2 cm) modular cube, flake or nugget ice makers	14" x 27" x 7"	B842	10/5
KBT31	MC222L	10" x 27" x 5"	B322	8/4
KBT38	All 22" (55.9 cm) modular cube, flake and nugget ice makers except MC222L	6" x 30" x 17"	B948	14/7
KBT38-2X	All 22" (55.9 cm) modular cube, flake and nugget ice makers except MC222L side by side	10" x 27" x 5"	B948	5/2
KBT39	All 22" (55.9 cm) modular cube, flake and nugget ice makers except MC222L	14" x 27" x 7"	B842	10/5
KBTABS	MC222L	26" x 24" x 7"	AB5	24/11
KBT80	MC222L	26" x 24" x 7"	IOD150	24/11
KBT81	MC222L	32" x 32" x 5"	IOD200, IOD250	25/11
KBT82	All 22" modular ice machines except MC222L	31" x 33" x 5"	IOD150	12/5
KBT83	All 22" modular cube and nugget ice makers except MC222L	33" x 47" x 5"	IOD200, IOD250	26/12
KBT84	All 30" modular cube ice makers	32" x 33" x 2"	IOD200, IOD250	13/5
KBT45	MC222L	32" x 31" x 5"	ED300	33/15

Bin Top Kits - BL1048, BL1360, BL1660, ICS

Model Number	Description	Shipping Dimensions L x W x H	Use On	Shipping Weight lb/kg
KBT70	Kit, Bin top for use with (2) 30" heads on BL1360 or BL1660	36" x 63" x 5"	BL1360, BL1660	70/32
KBT71	Kit, Bin top for use with 22" MC222L head on BL1048	36" x 63" x 5"	BL1048	70/32
KBT72	Kit, Bin top for use with (2) MC222L on BL1048	36" x 63" x 5"	BL1048	70/32
KBT73	Kit, Bin top for use with MC222L on BL1360, BL1660	36" x 63" x 5"	BL1360, BL1660	70/32
KBT74	Kit, Bin top for use with (2) MC222L on BL1360 or BL1660	36" x 63" x 5"	BL1360, BL1660	70/32
KBT75	Kit, Bin top for use with (2) 30" heads on ICS1360	36" x 63" x 5"	ICS1360	70/32

Accessory Kits



Model Number	Description	Shipping Weight lb/kg
Prodigy Plus® Nugget Dispenser Accessory Kits		
KDIL-PN-150	Kit, Ice Level Control with KVS, Prodigy Nugget on Cornelius DF or ED150	2/1
KDIL-PN-200	Kit, Ice Level Control with KVS, Prodigy Nugget on Cornelius DF or ED200	5/2
KDIL-PN-250	Kit, Ice Level Control with KVS, Prodigy Nugget on Cornelius DF or ED250	5/2
KDIL-PN-ID3	Kit, Ice Level Control with thermostat, Prodigy Nugget on Cornelius DF or ED300	2/1
KFSMF	Kit, manual fill nugget for Coca Cola Freestyle 9000 dispenser	3/1
KFSTM	Kit, top mounted nugget for Coca Cola Freestyle 9000 dispenser	3/1
KFS-LTP	Kit, Coca Cola Freestyle 9000 dispenser and Lancer TwinPour	5/2



Our XSafe® device is an optional sanitation system that is integrated on the top of your ice machine. XSafe® circulates cold oxygen plasma inside of the machine to help sanitize the air and surrounding surfaces. Operating automatically, this sanitation system runs all day long to ensure your equipment is clean and safe.

Unit Dimensions (W x D x H)	Model Number	Description	Shipping Weight lb/kg
 12" x 4 1/4" x 2 1/4" 30.5 x 10.8 x 5.7 cm	XSafe® Sanitation System	Sanitation system for helping eliminate viruses, bacteria and slime. Compatible with all modular units.	10/5
	XR-30		

AquaDefense® System - Sanitation Solution

Unit Dimensions (W x D x H)	Model Number	Description	Shipping Weight lb/kg
	AquaBullet® Anti Microbial Wand	6 pack of Antimicrobial wands to prevent slime and mold build up. Used for modular cube ice machines.	5/2
	ADS-AB6		
 AP1-P: 5 3/4" x 4 3/4" x 21 1/2" 14.3 x 12.1 x 54.6 cm AP2-P: 16 1/2" x 5 1/2" x 19 1/4" 41.9 x 14.0 x 48.9 cm AP3-P: 21" x 5 1/2" x 19 1/4" 53.3 x 14.0 x 48.9 cm	AquaPatrol™ Plus Water Filtration System	Single system - Cubers up to 650 lb (395 kg), flakers, nuggets and nugget dispensers up to 1,200 lb (544 kg) Twin System - Cubers over 650 lb (395 kg) and up to 1,200 lb (544 kg), flakers and nuggets over 1,200 lb (544 kg) Triple System - Cubers over 1,200 lb (544 kg) Replacement cartridge (package of 6) Replacement cartridge (package of 1)	7/3
	AP1-P		11/5
	AP2-P		16/7
	AP3-P		7/3
	APRC6-P		3/1.5
	APRC1-P		

Water Filtration Systems By Everpure®

Unit Dimensions (W x D x H)	Model Number	Description	Shipping Weight lb/kg
 SSM1 5 5/8" x 4 3/4" x 30 1/2" 14.3 x 12.1 x 77.5 cm SSM2 16 1/2" x 5 1/2" x 29 1/4" 41.9 x 14.0 x 74.0 cm SSM3 21" x 5 1/2" x 29 1/4" 53.3 x 14.0 x 74.0 cm	SSM Plus Filtration Systems with AquaArmor by AgION®		
	SSM1-P	Single system - Cubers up to 650 lb (395 kg), flakers, nuggets and nugget dispensers up to 1,200 lb (544 kg)	7/3
	SSM2-P	Twin System - Cubers over 650 lb (295 kg), flakers and nuggets over 1,200 lb (544 kg)	11/5
	SSM3-P	Triple System - Cubers over 1,200 lb (544 kg)	16/7
	SSMRC Replacement Cartridges		
	SSMRC1 SSMRC6	Single replacement cartridge (package of 1) 6 pack replacement cartridge (package of 6)	3/1.5 7/3
	SC Coarse Prefilters		
	SC10-A SC20-A	10" (25.4 cm) Coarse prefilter 20" (50.8 cm) Coarse prefilter	5/2 11/5
	SC Replacement Prefilters		
	SC10RC40 SC20RC20	SC10 replacement filter SC20 replacement filter	17/8 17/8

Water Filter Selection

Ice Form	Configuration	Model Number	AquaPatrol (System, Cartridge)	SSM Plus (System, Cartridge)
Cube	Self-Contained	CU50, CU0415, CU0515, CU0715, CU0920, UC2024, UC2724, CU3030,	AP1-P, APRC1-P	SSM1-P, SSMRC1
Cube	Up to 650 lbs	MC0322, MC0330, MC0522, MC0530, MC0630, MC0722	AP1-P, APRC1-P	SSM1-P, SSMRC1
Cube	Up to 1,200 lbs	MC0830, MC1030, MC222L	AP2-P, APRC1-P	SSM2-P, SSMRC1
Cube	Over 1,200 lbs	MC1448, MC1848, MC2148, MC2648, MC330L, MC430L	AP3-P, APRC1-P	SSM3-P, SSMRC1
Nugget/Flake	Self-Contained/Dispenser	HID207, HID312, HID525, HID540, UF0915, UF1415, UF424, UN0815, UN1215, UN324	AP1-P, APRC1-P	SSM1-P, SSMRC1
Nugget/Flake	Up to 1,200 lbs	F0522, F0822, F1222, N0422, N0622, N0922	AP1-P, APRC1-P	SSM1-P, SSMRC1
Nugget/Flake	Over 1,200 lbs	F1522, F2330, FME2404, N1322, N2030, NME1854	AP2-P, APRC1-P	SSM2-P, SSMRC1



Scan to View
Current Pricing

CHARTS & INDEX

ICE MACHINE TO DISPENSER KIT CHART	33
MACHINE / BIN SIZING CHART	34-35
INDEX	36-38
WARRANTY & DEFINITIONS	39



Ice Machine to Dispenser Kit Application Chart

Company	Dispenser	Ice Machines MC222L	MC0322/522/722	MC0330/530/630/830 /1030/330L/430L	N0422/622 922/1322
Cornelius	ED150	620201029*	620201013TE*		620201013TE* KDIL-PN-150
Cornelius	DF150	629087959*	02388*		02388* KDIL-PN-150
Cornelius	ED175	629087571*	629093782TE*		KDIL-PN-150 629093782TE*
Cornelius	ED200	620201028*	620201015TE*	620201017TE*	620201015TE* KDIL-PN-200
	DF200	629087572*	08035*	08004*	
Cornelius	ED250	620201028*	620201015TE*	620201017TE, KBILC**	620201015TE* KDIL-PN-250
	DF250	629087572*	08035*	08004*, KBILC**	
Cornelius	ED300	KBT45	08028*	629087943*	KDIL-PN-ID3 629087966* 629088644*
	DF300	KBT45	08028*	629087943*	
Cornelius	Flavor Fusion 255	629088666*	KBILC** 629088502*	KBILC** 629088505*	KVS 629088681* 629097086*
	IDC215/ID255	629088662*	KBILC** 629088537*	KBILC** 629088536*	KVS 629088677* 629097086*
Lancer	22" Wide	82-4063*	82-4062*		KVS A40403-021 82-3955*
Lancer	30" Wide	82-4061*	82-4060*	82-4059*, KBILC**	KVS A40403-021 82-3633/02*
SerVend	S-150/SV-150	SL27-020000246*	SL30-020000249* CL10-5012116*		KVS SL30-020000249 CL10-5012116*
SerVend	SV-175	SL22-020000198*	SL24-020000200*		KVS SL24-020000200*
SerVend	S-200/SV-200 S-250/SV-250	SL17-5031150*	SL25-5031609*	N3-5031125* CL10-5012116*	KVS SL25-5031609*
Coca-Cola	Freestyle 9000 (free standing)	Contact Coca-Cola for bin adapters	KVS, or KBILC Contact Coca-Cola for bin adapters		KFSTM Contact Coca-Cola for bin adapters
Coca-Cola	Freestyle 7000 (countertop)	Contact Coca-Cola for bin adapters	KVS, or KBILC Contact Coca-Cola for bin adapters	KVS, or KBILC Contact Coca-Cola for bin adapters	11-0353-23 Contact Coca-Cola for bin adapters

* Non Scotsman kits must be purchased from the dispenser manufacturer.
** Recommended but not required.

- Please check with dispenser manufacturer for appropriate kits. Application chart subject to change.
- Blank cells indicate cannot be used together, N/A indicates no adapter needed.
- See spare parts price list for Scotsman A37693-021 & R629088514 pricing.
- Lancer dispensers must be specially configured for dispensing Scotsman Nugget Ice®
- Some Cornelius adapters kits include binstats - do not use the thermostats.
- All Cornelius ED/DF adapter kits have gray doors/covers. Contact Cornelius for black.
- All Cornelius FlavorFusion adapter kits are midnight black. Contact Cornelius for silver, orange or green.
- All Cornelius IDC255 adapter kits are black.

Machine / Bin Sizing Chart

Dimensions in W x D x H - (Height includes 6" legs)

No bin top required when KBT not listed.

	BINS (Storage)	B322S	B330P	B530P/S	B842S	B948S	BL1048S*	BL1360S*	BL1660S*
ICE MAKERS (Production)	LBS	370	344	536	778	893	1000	1320	1660
MC0322 MC0522	300 500	22" x 34" x 73" 55.9 x 86.4 x 185.4 cm	30" x 34" x 59" 76.2 x 86.4 x 149.9 cm w/KBT27 top	30" x 34" x 73" 76.2 x 86.4 x 185.4 cm w/KBT27 top	42" x 34" x 73" 106.2 x 86.4 x 185.4 cm w/KBT39 top	48" x 34" x 73" 121.9 x 86.4 x 185.4 cm w/KBT38 top or KBT38-2x - side by side			
MC0722	700	22" x 34" x 76" 55.9 x 86.4 x 193.0 cm	30" x 34" x 65" 76.2 x 86.4 x 165.1 cm w/KBT27 top	30" x 34" x 79" 76.2 x 86.4 x 200.7 cm w/KBT27 top	42" x 34" x 79" 106.2 x 86.4 x 200.7 cm w/KBT39 top	48" x 34" x 79" 121.9 x 86.4 x 200.7 cm w/KBT38 top or KBT38-2x - side by side	48" x 31" x 84" 121.9 x 78.7 x 213.3 cm	60" x 31" x 84" 152.4 x 78.7 x 213.3 cm	60" x 31" x 93" 152.4 x 78.7 x 236.2 cm
MC0330 MC0530 MC0630	300 500 600		30" x 34" x 59" 76.2 x 86.4 x 149.9 cm	30" x 34" x 73" 76.2 x 86.4 x 185.4 cm	42" x 34" x 73" 106.7 x 86.4 x 185.4 cm w/KBT29 top	48" x 34" x 73" 121.9 x 86.4 x 185.4 cm w/KBT22B top			
MC0830 MC1030	800 1000			30" x 34" x 79" 76.2 x 86.4 x 200.7 cm	42" x 34" x 79" 106.2 x 86.4 x 200.7 cm w/KBT29 top	48" x 34" x 79" 121.9 x 86.4 x 200.7 cm w/KBT22B top	48" x 31" x 84" 121.9 x 78.7 x 213.3 cm	60" x 31" x 84" 152.4 x 78.7 x 213.3 cm	60" x 31" x 93" 152.4 x 78.7 x 236.2 cm
MC1448 MC1848 MC2148	1400 1800 2000					48" x 34" x 79" 121.9 x 86.4 x 200.7 cm	48" x 31" x 84" 121.9 x 78.7 x 213.3 cm	60" x 31" x 84" 152.4 x 78.7 x 213.3 cm	60" x 31" x 93" 152.4 x 78.7 x 236.2 cm
MC2648	2600					48" x 34" x 84" 121.9 x 86.4 x 213.4 cm	48" x 31" x 89" 121.9 x 78.7 x 226 cm	60" x 31" x 89" 152.4 x 78.7 x 226 cm	60" x 31" x 98" 152.4 x 78.7 x 248.9 cm
MC222L	800 1000						48" x 31" x 84" 121.9 x 78.7 x 213.3 cm w/ KBT71 or KBT72 - side by side	60" x 31" x 84" 152.4 x 78.7 x 213.3 cm w/ KBT73 or KBT74 - side by side	60" x 31" x 93" 152.4 x 78.7 x 236.2 cm w/ KBT73 or KBT74 - side by side
MC330L	1400				42" x 34" x 73" 106.2 x 86.4 x 185.4 cm w/KBT29 top	48" x 34" x 73" 121.9 x 86.4 x 200.7 cm w/KBT22B top	48" x 31" x 78" 121.9 x 78.7 x 198.1 cm	60" x 31" x 78" 152.4 x 78.7 x 198.1 cm	60" x 31" x 87" 152.4 x 78.7 x 221 cm
MC430L	1400 1800				42" x 34" x 79" 106.2 x 86.4 x 200.7 cm w/KBT29 top	48" x 34" x 79" 121.9 x 86.4 x 200.7 cm w/KBT22B top	48" x 31" x 84" 121.9 x 78.7 x 213.3 cm	60" x 31" x 84" 152.4 x 78.7 x 213.3 cm	60" x 31" x 93" 152.4 x 78.7 x 236.2 cm
N0422 N0622	400 600	22" x 34" x 73" 55.9 x 86.4 x 184.4 cm	30" x 34" x 59" 76.2 x 86.4 x 149.9 cm w/KBT27 top	30" x 34" x 73" 76.2 x 86.4 x 185.4 cm w/KBT27 top	42" x 34" x 73" 106.2 x 86.4 x 185.4 cm w/KBT39 top	48" x 34" x 73" 121.9 x 86.4 x 185.4 cm w/KBT38 top or KBT38-2x - side by side			
N0922 N1322	900 1300	22" x 34" x 77" 55.9 x 86.4 x 195.6 cm	30" x 34" x 63" 76.2 x 86.4 x 160.0 cm w/KBT27 top	30" x 34" x 77" 76.2 x 86.4 x 195.6 cm w/KBT27 top	42" x 34" x 77" 106.2 x 86.4 x 195.6 cm w/KBT39 top	48" x 34" x 77" 121.9 x 86.4 x 195.6 cm w/KBT38 top or KBT38-2x - side by side	48" x 31" x 84" 121.9 x 78.7 x 213.3 cm	60" x 31" x 84" 152.4 x 78.7 x 213.3 cm	60" x 31" x 93" 152.4 x 78.7 x 236.2 cm
N2030	2000			30" x 34" x 79" 76.2 x 86.4 x 200.7 cm	42" x 34" x 79" 106.2 x 86.4 x 200.7 cm w/KBT29 top	48" x 34" x 79" 121.9 x 86.4 x 200.7 cm w/KBT22B top	48" x 31" x 84" 121.9 x 78.7 x 213.3 cm	60" x 31" x 84" 152.4 x 78.7 x 213.3 cm	60" x 31" x 93" 152.4 x 78.7 x 236.2 cm
F0522 F0822	500 800	22" x 34" x 73" 55.9 x 86.4 x 184.4 cm	30" x 34" x 59" 76.2 x 86.4 x 149.9 cm w/KBT27 top	30" x 34" x 73" 76.2 x 86.4 x 185.4 cm w/KBT27 top	42" x 34" x 73" 106.2 x 86.4 x 185.4 cm w/KBT39 top	48" x 34" x 73" 121.9 x 86.4 x 185.4 cm w/KBT38 top or KBT38-2x - side by side	48" x 31" x 78" 121.9 x 78.7 x 198.1 cm	60" x 31" x 78" 152.4 x 78.7 x 198.1 cm	60" x 31" x 87" 152.4 x 78.7 x 221 cm
F1222 F1522	1200 1500	22" x 34" x 77" 55.9 x 86.4 x 195.6 cm	30" x 34" x 63" 76.2 x 86.4 x 160.0 cm w/KBT27 top	30" x 34" x 77" 76.2 x 86.4 x 195.6 cm w/KBT27 top	42" x 34" x 77" 106.2 x 86.4 x 195.6 cm w/KBT39 top	48" x 34" x 77" 121.9 x 86.4 x 195.6 cm w/KBT38 top or KBT38-2x - side by side	48" x 31" x 84" 121.9 x 78.7 x 213.3 cm	60" x 31" x 84" 152.4 x 78.7 x 213.3 cm	60" x 31" x 93" 152.4 x 78.7 x 236.2 cm
F2330	2300			30" x 34" x 79" 76.2 x 86.4 x 200.7 cm	42" x 34" x 79" 106.2 x 86.4 x 200.7 cm w/KBT29 top	48" x 34" x 79" 121.9 x 86.4 x 200.7 cm w/KBT22B top	48" x 31" x 84" 121.9 x 78.7 x 213.3 cm	60" x 31" x 84" 152.4 x 78.7 x 213.3 cm	60" x 31" x 93" 152.4 x 78.7 x 236.2 cm
FME2404	2400				42" x 34" x 77" 106.2 x 86.4 x 195.6 cm	48" x 34" x 77" 121.9 x 86.4 x 195.6 cm w/KBT14A top	48" x 31" x 82" 121.9 x 78.7 x 208.3 cm	60" x 31" x 82" 152.4 x 78.8 x 208.3 cm	60" x 31" x 91" 152.4 x 78.7 x 231.1 cm

*Universal bin top adapter included for most applications. See above chart for adapters (if applicable).

Ice Only Dispensers

Hotel D-Bins

Ice Only Dispensers				Hotel D-Bins	
IOD150	IOD200	IOD250		HD22	HD30
150	200	250		120	180
22" x 31 1/2" x 58" 55.9 x 77.5 x 145.4 cm w/KBT82 top	30" x 31 1/2" x 59 3/4" 76.2 x 77.5 x 149.9 cm w/KBT83 top	30" x 31 1/2" x 64 1/2" 76.2 x 77.5 x 160.0 cm w/KBT83 top		22" x 33 1/2" x 76 1/4" 55.9 x 85.1 x 193.7 cm	
22" x 31 1/2" x 64" 55.9 x 77.5 x 160.7 cm w/KBT82 top	30" x 31 1/2" x 65 3/4" 76.2 x 77.5 x 165.1 cm w/KBT83 top	30" x 31 1/2" x 70 1/2" 76.2 x 77.5 x 175.3 cm w/KBT83 top		22" x 33 1/2" x 82 1/4" 55.9 x 85.1 x 208.9 cm	
	30" x 31 1/2" x 58" 76.2 x 77.5 x 145.4 cm w/KBT84 top	30" x 31 1/2" x 62 3/4" 76.2 x 77.5 x 155.6 cm w/KBT84 top			30" x 33 1/2" x 76 1/4" 76.2 x 85.1 x 193.7 cm
	30" x 31 1/2" x 64" 76.2 x 77.5 x 160.7cm w/KBT84 top	30" x 31 1/2" x 68 3/4" 76.2 x 77.5 x 170.8 cm w/KBT84 top			
22" x 31 1/2" x 65" 55.9 x 77.5 x 163.2 cm w/KBT80 top	30" x 31 1/2" x 65 1/4" 76.2 x 77.5 x 163.2 cm w/KBT84 top	30" x 31 1/2" x 69 3/4" 76.2 x 77.5 x 173.4 cm w/KBT84 top			
	30" x 31 1/2" x 58 1/4" 76.2 x 77.5 x 145.4 cm w/KBT84 top	30" x 31 1/2" x 63 3/4" 76.2 x 77.5 x 145.4 cm w/KBT84 top			
	30" x 31 1/2" x 64" 76.2 x 77.5 x 160.7cm w/KBT84 top	30" x 31 1/2" x 68 3/4" 76.2 x 77.5 x 170.8 cm w/KBT84 top			
22" x 31 1/2" x 58" 55.9 x 77.5 x 145.4 cm w/KBT82 top, KNUGAGT	30" x 31 1/2" x 59 3/4" 76.2 x 77.5 x 149.9 cm w/KBT83 top KVS, KNUGAGT	30" x 31 1/2" x 64 1/2" 76.2 x 77.5 x 160.0 cm w/KBT83 top KVS, KNUGAGT			
22" x 31 1/2" x 62" 55.9 x 77.5 x 155.6 cm w/KBT82 top, KNUGAGT	30" x 31 1/2" x 63 3/4" 76.2 x 77.5 x 160.0 cm w/KBT83 top KVS, KNUGAGT	30" x 31 1/2" x 68 1/2" 76.2 x 77.5 x 170.2 cm w/KBT83 top KVS, KNUGAGT			
	30" x 31 1/2" x 64" 76.2 x 77.5 x 160.7cm w/KBT84 top KVS, KNUGAGT	30" x 31 1/2" x 68 3/4" 76.2 x 77.5 x 170.8 cm w/KBT84 top KVS, KNUGAGT			

INDEX

3BRTE20-EH	PG. 13	ECC0800-6	PG. 12, 13	HID525W-1	PG. 25
3BRTE35-EH	PG. 13	ECC1200-32	PG. 12, 13	HID540A-1	PG. 25
3BRTE50-EH	PG. 13	ECC1410-3	PG. 12, 13	HID540A-6	PG. 25
3BRTE75-EH	PG. 13	ECC1410-32	PG. 12, 13	HID540AW-1	PG. 25
ADS-AB6	PG. 30	ECC1800-3	PG. 12, 13	HID540W-1	PG. 25
AP1-P	PG. 30	ERC111-1	PG. 11, 21	HST16-A	PG. 25
AP2-P	PG. 30	ERC311-32	PG. 11, 21	HST16B-A	PG. 25
AP3-P	PG. 30	ERC311-6	PG. 11, 21	HST21-A	PG. 25
APRC1-P	PG. 30	ERC611-32	PG. 11	HST21B-A	PG. 25
APRC6-P	PG. 30	FS0522A-1	PG. 17	HSTCD16-A	PG. 25
B322S	PG. 27	FS0522W-1	PG. 17	ICS1360	PG. 28
B330P	PG. 27	FS0822A-1	PG. 17	ICS1790	PG. 28
B530P	PG. 27	FS0822R-1	PG. 17	ICS730	PG. 28
B530S	PG. 27	FS0822W-1	PG. 17	ICS-CP	PG. 28
B842S	PG. 27	FS0822W-32	PG. 17	ICS-DIVIDE	PG. 28
B948S	PG. 27	FS1222A-3	PG. 17	ICS-PADDLE	PG. 28
BGS10	PG. 28	FS1222A-32	PG. 17	ICS-SHOVEL	PG. 28
BL1048S	PG. 27	FS1222A-6	PG. 17	ICS-TOTE	PG. 28
BL1360S	PG. 27	FS1222L-1	PG. 20	IOD150	PG. 26
BL1660S	PG. 27	FS1222R-3	PG. 17	IOD200	PG. 26
BRTE10	PG. 11, 21	FS1222R-32	PG. 17	IOD250	PG. 26
BRTE25	PG. 11, 21	FS1222W-32	PG. 17	IODST22	PG. 27
BRTE40	PG. 11, 21	FS1522A-32	PG. 17	IODST30	PG. 27
BRTE75	PG. 11, 21	FS1522L-1	PG. 20	KBAG	PG. 28
BRTEL25	PG. 11	FS1522R-32	PG. 17	KBC1	PG. 28
BRTEL40	PG. 11	FS2330L-32	PG. 20	KBC1P	PG. 28
BRTEL75	PG. 11	FS2330R-3	PG. 17	KBILC	PG. 11
CU0415MA-1	PG. 15	FS2330R-32	PG. 17	KBT14A	PG. 29
CU0415MA-6	PG. 15	FS2330W-3	PG. 17	KBT22B	PG. 29
CU0715MA-1	PG. 15	FS2330W-32	PG. 17	KBT27	PG. 29
CU0715MA-6	PG. 15	HD22B-1	PG. 26	KBT29	PG. 29
CU0920MA-1	PG. 15	HD22B-6	PG. 26	KBT31	PG. 29
CU0920MA-6	PG. 15	HD30B-1	PG. 26	KBT32	PG. 29
CU3030MA-1	PG. 15	HD30B-6	PG. 26	KBT38	PG. 29
CU3030MA-32	PG. 15	HD30W-1	PG. 26	KBT38-2X	PG. 29
CU3030MA-6	PG. 15	HID207ABX-1	PG. 25	KBT39	PG. 29
CU3030SA-1	PG. 15	HID207AX-1	PG. 25	KBT45	PG. 29
CU3030SA-32	PG. 15	HID312A-1	PG. 25	KBT50	PG. 29
CU3030SA-6	PG. 15	HID312A-6	PG. 25	KBT51	PG. 29
CU3030SW-1	PG. 15	HID312AW-1	PG. 25	KBT52	PG. 29
CU50GA-1	PG. 13	HID525A-1	PG. 25	KBT53	PG. 29
CU50PA-1	PG. 13	HID525A-6	PG. 25	KBT54	PG. 29
ECC0800-3	PG. 12, 13	HID525AW-1	PG. 25	KBT62	PG. 29

KBT63	PG. 29	KVS	PG. 11, 21	MC0722SA-32	PG. 9
KBT70	PG. 29	MC0322MA-1	PG. 9	MC0722SA-6	PG. 9
KBT71	PG. 29	MC0322MA-32	PG. 9	MC0830MA-3	PG. 10
KBT72	PG. 29	MC0322MA-6	PG. 9	MC0830MA-32	PG. 10
KBT73	PG. 29	MC0322MW-1	PG. 9	MC0830MA-6	PG. 10
KBT74	PG. 29	MC0322SA-1	PG. 9	MC0830MR-32	PG. 10
KBT75	PG. 29	MC0322SA-6	PG. 9	MC0830MW-32	PG. 10
KBT80	PG. 29	MC0322SW-1	PG. 9	MC0830SA-3	PG. 10
KBT81	PG. 29	MC0322SW-32	PG. 9	MC0830SA-32	PG. 10
KBT82	PG. 29	MC0330MA-1	PG. 9	MC0830SA-32	PG. 10
KBT83	PG. 29	MC0330MA-32	PG. 9	MC0830SR-32	PG. 10
KBT84	PG. 29	MC0330MW-1	PG. 9	MC0830SR-6	PG. 10
KBTABS	PG. 29	MC0330SA-1	PG. 9	MC0830SW-32	PG. 10
KCMR-230	PG. 21	MC0330SW-1	PG. 9	MC1030MA-32	PG. 10
KDIL-PN-150	PG. 29	MC0522MA-1	PG. 9	MC1030MA-6	PG. 10
KDIL-PN-200	PG. 29	MC0522MA-32	PG. 9	MC1030MR-3	PG. 10
KDIL-PN-250	PG. 29	MC0522MA-6	PG. 9	MC1030MR-32	PG. 10
KDIL-PN-ID3	PG. 29	MC0522MW-1	PG. 9	MC1030MW-32	PG. 10
KERCF	PG. 11, 21	MC0522SA-1	PG. 9	MC1030SA-32	PG. 10
KFS-LTP	PG. 29	MC0522SA-32	PG. 9	MC1030SA-6	PG. 10
KFSMF	PG. 29	MC0522SA-6	PG. 9	MC1030SR-3	PG. 10
KFSTM	PG. 29	MC0522SW-1	PG. 9	MC1030SR-32	PG. 10
KHDSANLV	PG. 26	MC0522SW-32	PG. 9	MC1030SR-6	PG. 10
KHOLDER	PG. 28	MC0530MA-1	PG. 9	MC1030SW-32	PG. 10
KLP24A	PG. 25	MC0530MA-32	PG. 9	MC1448MA-3	PG. 10
KLP7	PG. 28	MC0530MA-6	PG. 9	MC1448MA-32	PG. 10
KLP8S	PG. 28	MC0530MR-1	PG. 9	MC1448MA-6	PG. 10
KNUGAGT	PG. 27	MC0530MW-1	PG. 9	MC1448MR-3	PG. 10
KNUGDIV	PG. 27	MC0530SA-1	PG. 9	MC1448MR-32	PG. 10
KPAS	PG. 11, 21	MC0530SA-32	PG. 9	MC1448MW-3	PG. 10
KPFHM-E	PG. 21	MC0530SA-6	PG. 9	MC1448MW-32	PG. 10
KPUFM30	PG. 15	MC0530SR-1	PG. 9	MC1448SA-3	PG. 10
KSBU	PG. 11, 21	MC0530SW-1	PG. 9	MC1448SA-32	PG. 10
KSBU-N	PG. 11, 21	MC0630MA-32	PG. 9	MC1448SA-6	PG. 10
KSEALER	PG. 28	MC0630MA-6	PG. 9	MC1448SR-3	PG. 10
KTAPE	PG. 28	MC0630MR-32	PG. 9	MC1448SR-32	PG. 10
KTE4	PG. 11, 21	MC0630MW-32	PG. 9	MC1448SW-3	PG. 10
KTE6-EH	PG. 13	MC0630SA-32	PG. 9	MC1448SW-32	PG. 10
KTEL4	PG. 11	MC0630SA-6	PG. 9	MC1848MA-32	PG. 10
KTPS-SM	PG. 11	MC0630SR-32	PG. 9	MC1848MA-6	PG. 10
KUFM15	PG. 15, 23	MC0630SW-32	PG. 9	MC1848MR-3	PG. 10
KUFM20	PG. 15, 23	MC0722MA-32	PG. 9	MC1848MR-32	PG. 10
KUFM24	PG. 15, 23	MC0722MA-6	PG. 9	MC1848MR-6	PG. 10

MC1848MW-32	PG. 10	NS0622A-1	PG. 19	UC2724SW-1	PG. 15
MC1848SA-32	PG. 10	NS0622A-32	PG. 19	UF0915A-1	PG. 23
MC1848SA-6	PG. 10	NS0622A-6	PG. 19	UF1415A-1	PG. 23
MC1848SR-3	PG. 10	NS0622R-1	PG. 19	UF2020A-1	PG. 23
MC1848SR-32	PG. 10	NS0622W-1	PG. 19	UF424A-1	PG. 23
MC1848SR-6	PG. 10	NS0922A-1	PG. 19	UF424A-6	PG. 23
MC1848SW-32	PG. 10	NS0922A-32	PG. 19	UF424W-1	PG. 23
MC2148MR-3	PG. 10	NS0922A-6	PG. 19	UN0815A-1	PG. 23
MC2148MR-32	PG. 10	NS0922L-1	PG. 20	UN1215A-1	PG. 23
MC2148MR-6	PG. 10	NS0922R-1	PG. 19	UN1520A-1	PG. 23
MC2148SR-3	PG. 10	NS0922R-32	PG. 19	UN324A-1	PG. 23
MC2148SR-32	PG. 10	NS0922W-3	PG. 19	UN324A-6	PG. 23
MC2148SR-6	PG. 10	NS0922W-32	PG. 19	UN324W-1	PG. 23
MC222L	PG. 12	NS1322A-32	PG. 19	XR-30	PG. 30
MC2648MR-3	PG. 10	NS1322L-1	PG. 20		
MC2648SR-3	PG. 10	NS1322R-32	PG. 19		
MC330L	PG. 12	NS1322W-3	PG. 19		
MC430L	PG. 12	NS1322W-32	PG. 19		
NH0422A-1	PG. 19	NS2030R-3	PG. 19		
NH0422W-1	PG. 19	NS2030R-32	PG. 19		
NH0622A-1	PG. 19	NS2030W-3	PG. 19		
NH0622A-32	PG. 19	NS2030W-32	PG. 19		
NH0622R-1	PG. 19	PRC241-32	PG. 11		
NH0622W-1	PG. 19	RCKCME6GX-E	PG. 11		
NH0922A-1	PG. 19	SC10-A	PG. 31		
NH0922A-32	PG. 19	SC10RC40	PG. 31		
NH0922L-1	PG. 20	SC20-A	PG. 31		
NH0922R-1	PG. 19	SC20RC20	PG. 31		
NH0922R-32	PG. 19	SSM1-P	PG. 31		
NH0922W-32	PG. 19	SSM2-P	PG. 31		
NH1322A-32	PG. 19	SSM3-P	PG. 31		
NH1322L-1	PG. 20	SSMRC1	PG. 31		
NH1322R-32	PG. 19	SSMRC6	PG. 31		
NH1322W-3	PG. 19	UC0918GAX-1	PG. 13		
NH1322W-32	PG. 19	UC2024MA-1	PG. 15		
NH2030R-3	PG. 19	UC2024MW-1	PG. 15		
NH2030R-32	PG. 19	UC2024SA-1	PG. 15		
NH2030W-3	PG. 19	UC2024SW-1	PG. 15		
NH2030W-32	PG. 19	UC2724MA-1	PG. 15		
NME1854RS-32	PG. 20	UC2724MA-6	PG. 15		
NRTE45	PG. 21	UC2724MW-1	PG. 15		
NS0422A-1	PG. 19	UC2724SA-1	PG. 15		
NS0422W-1	PG. 19	UC2724SA-6	PG. 15		

Commercial Product Warranty Information



Warranty*

Prodigy Plus[®], Eclipse[®] Cubes, iceValet[®] Hotel Dispensers & Bins

(EH, ERC, ECC, HD, BL, B, C0, C1, C2, MC, CB & PR)
3 years parts
3 years labor
5 years parts & labor on Prodigy Evaporator, BL1360, BL1048, BL1660 & ICS systems
5 years parts on compressor & condenser

Prodigy Plus[®] & AutoSentry[™] Flake & Nugget Ice Machines

(FM, NM, FS, NH & NS)
3 years parts
3 years labor
5 years parts on compressor

15" & 20" Wide Undercounter Ice Machines

(CU0415, CU0715, CU0920, UF0915, UF1415, UF2020, UN0815, UN1215, UN1520)
3 years parts
3 years labor

24" Wide Undercounter Ice Machines

(UC2024, UC2724, UF424, UN324)
3 years parts
3 years labor
5 years parts on compressor

Undercounter Gourmet Ice Machines

(CU50) (UC0918)
1 years parts 3 years parts
1 years labor 3 years labor
5 years parts on compressor 5 years parts on compressor & condenser

Undercounter Cube Ice Machine

(CU3030)
3 years parts
3 years labor
5 years parts & labor on the evaporator
5 years parts on compressor & condenser

Meridian[™] Ice & Water Dispensers

(HID)
3 years parts
3 years labor
5 years parts on compressor & condenser

Water Filtration Systems

(SSM & AP)
5 years on manifold parts only (SSMx-P & SCx0-A)

Ice Only Dispensers

(IOD)
2 years parts
1 years labor

* Warranty valid in North, South & Central America for commercial installations.
Residential warranty on commercial products: 1 year parts and labor.

Definitions

- Maximum production capabilities are typical peak production for 24 hours at 70°F/21°C air and 50°F/10°C water
- AHRI certified production capabilities are typical peak production for 24 hours at 90°F/32°C air and 70°F/21°C water
- Maximum capacity is based on 90% of total volume in cubic feet x 34 lb/ft
- (SS) Stainless Steel
- (RC) Rotocast Plastic
- (R-Air) Remote Air
- (RLS) Remote Lowside
- Freight F.O.B. Fairfax, South Carolina

Scotsman®



• 101 Corporate Woods Parkway, Vernon Hills, IL 60061 • 1-800-SCOTSMAN • Fax: 847-913-9844 • www.scotsman-ice.com • orders@scotsman-ice.com • © 2024 Scotsman Ice Systems. SIS-BR-CPG_0225



Scan to View
Current Pricing

YouTube
@Scotsman-Ice

